

# PASCAS CARE

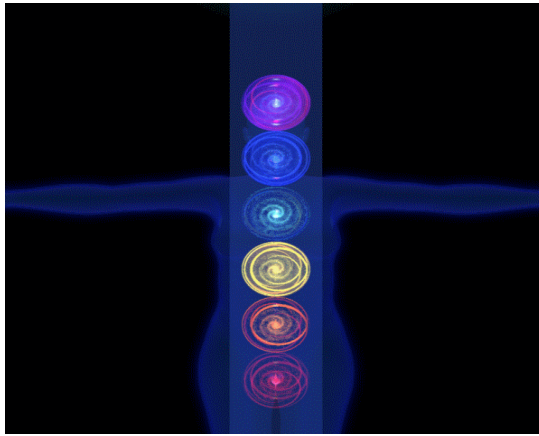

PASCAS HEALTH SANCTUARY

PASCAS CARE CENTRE

# PASCAS CARE

**“Peace And Spirit  
Creating Alternative Solutions”**



# PASCAS CARE

PASCAS CARE is to:

- Make available solutions for the management of life threatening diseases in emerging and remote economies.
- Support environmentally sustainable economic practices and their implementation.
- Embrace the enhancement of the welfare of all who come into contact with Pascas; community, staff, suppliers and their families.

# PASCAS CARE

PASCAS CARE is about education:

- Nutritional values for health maintenance.
- Enlightenment for a healthier way of life.
- New technology applications for sustenance of the family and enrichment via new income opportunities.
- Training of staff and all who can benefit from research and knowledge developed within and made available to Pascas.

# PASCAS HEALTH SANCTUARY

## GLOBAL CENTRES of EXCELLENCE

**Brazil**

**Nigeria**

**Australia**

**South Africa**



# PASCAS HEALTH SANCTUARY

Melding:

- Western Allopathic medicine with
- Complementary Therapies

thus achieving

- Natural Medicinal Hospitals & Clinics

whilst realising the relevance of emerging

- Vibrationally focused energy therapy.



# PASCAS HEALTH SANCTUARY



# PASCAS HEALTH SANCTUARY

- 300 bed medical surgical Hospital
- 8 major operating theatres
- Day complex 4 operating theatres
- Diagnostic / imaging centre
- Western medicine medical centre
- Complementary therapy medical centre
- 150 – 420 room medi-hotel



# HEALTHY BUILDINGS for HEALING PEOPLE



## HEALING GARDEN

# CLEAN AIR

## SOURCES OF INDOOR POLLUTANTS

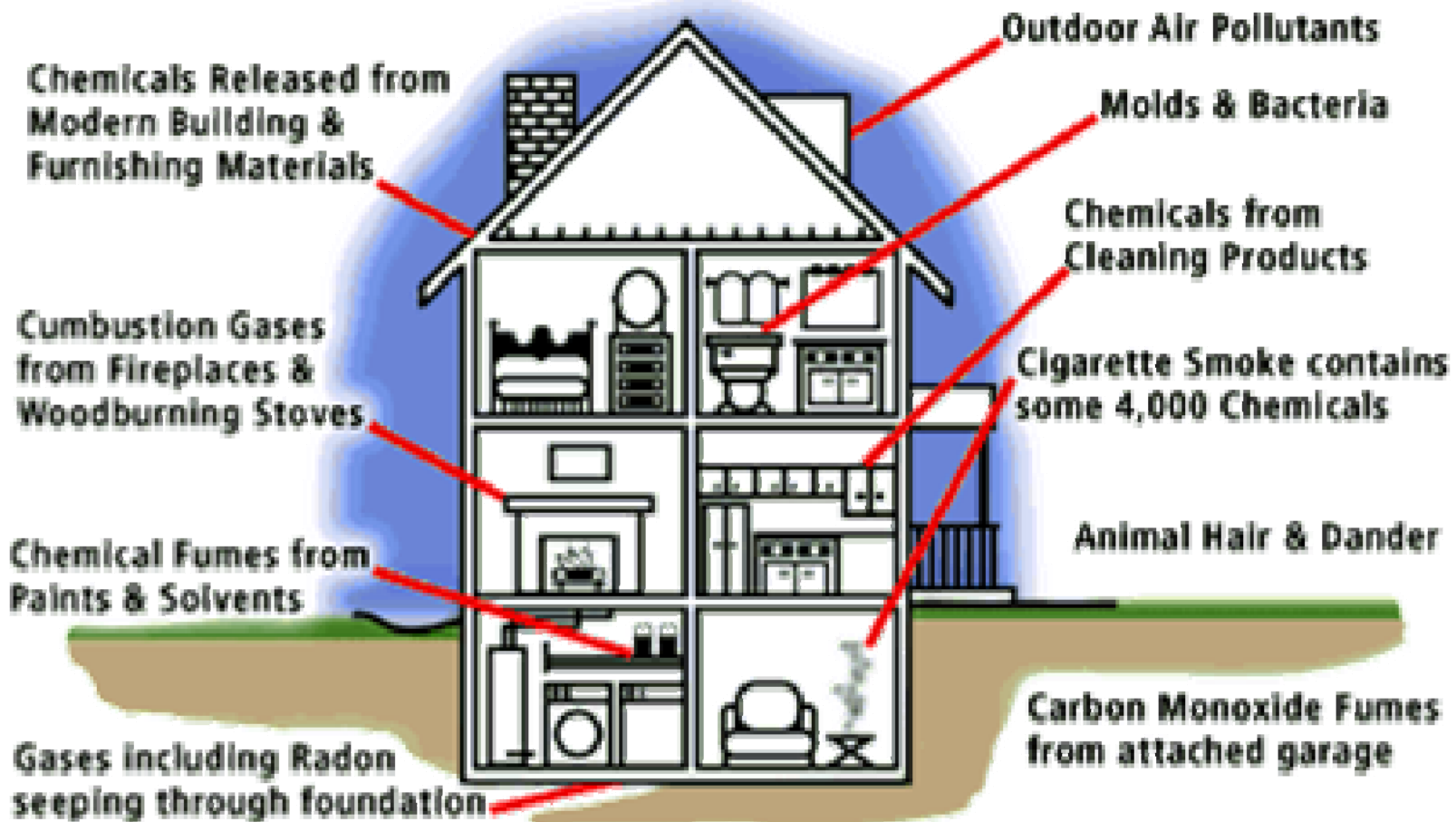

# CLEAN WATER

## Micro-cluster Water

World's Purest Water

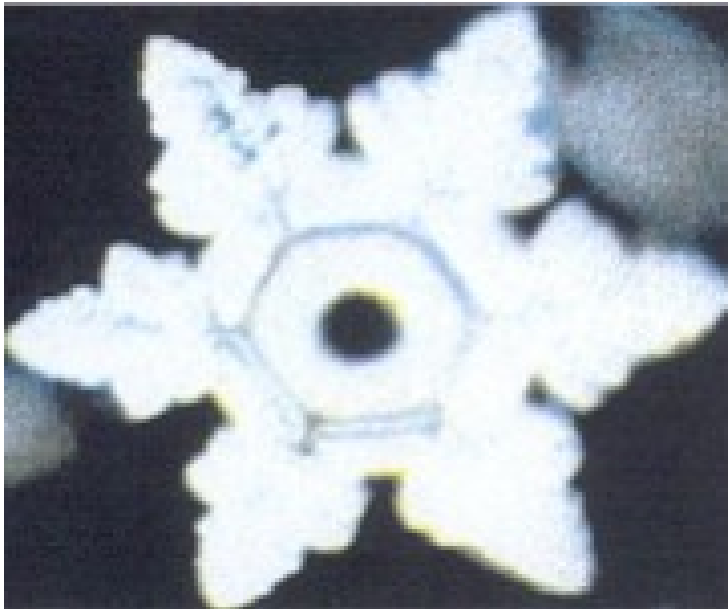

Clustered Water

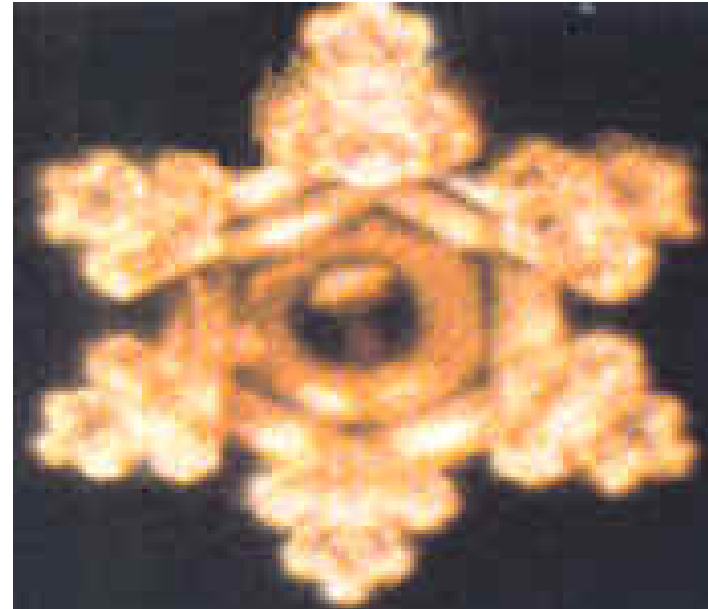

# MEDI-HOTEL also a SPA RESORT



# PASCAS HEALTH SANCTUARY





# PASCAS HEALTH SANCTUARY

Baby Sam – at 21 weeks!

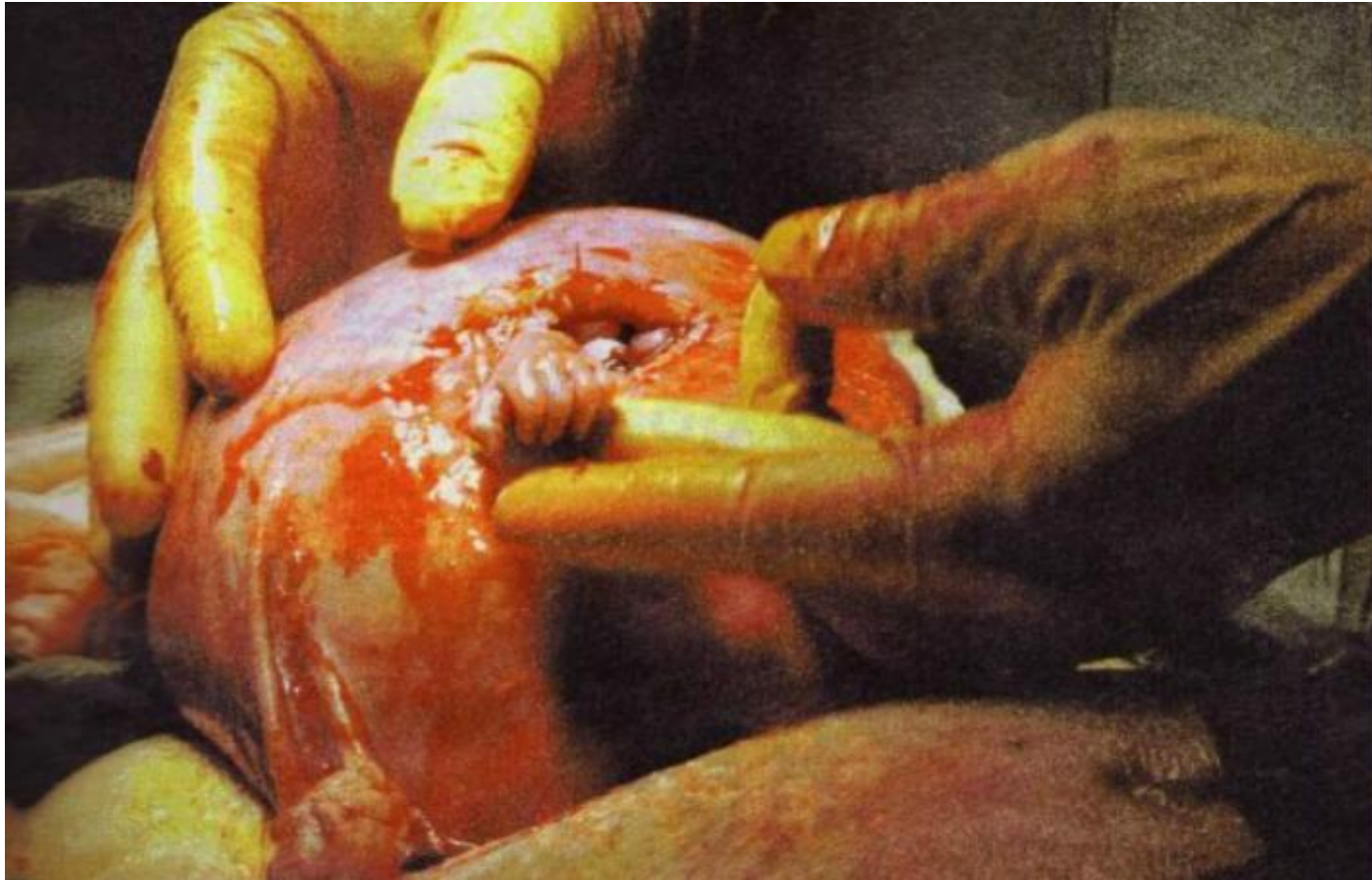



# HEALTH DOME

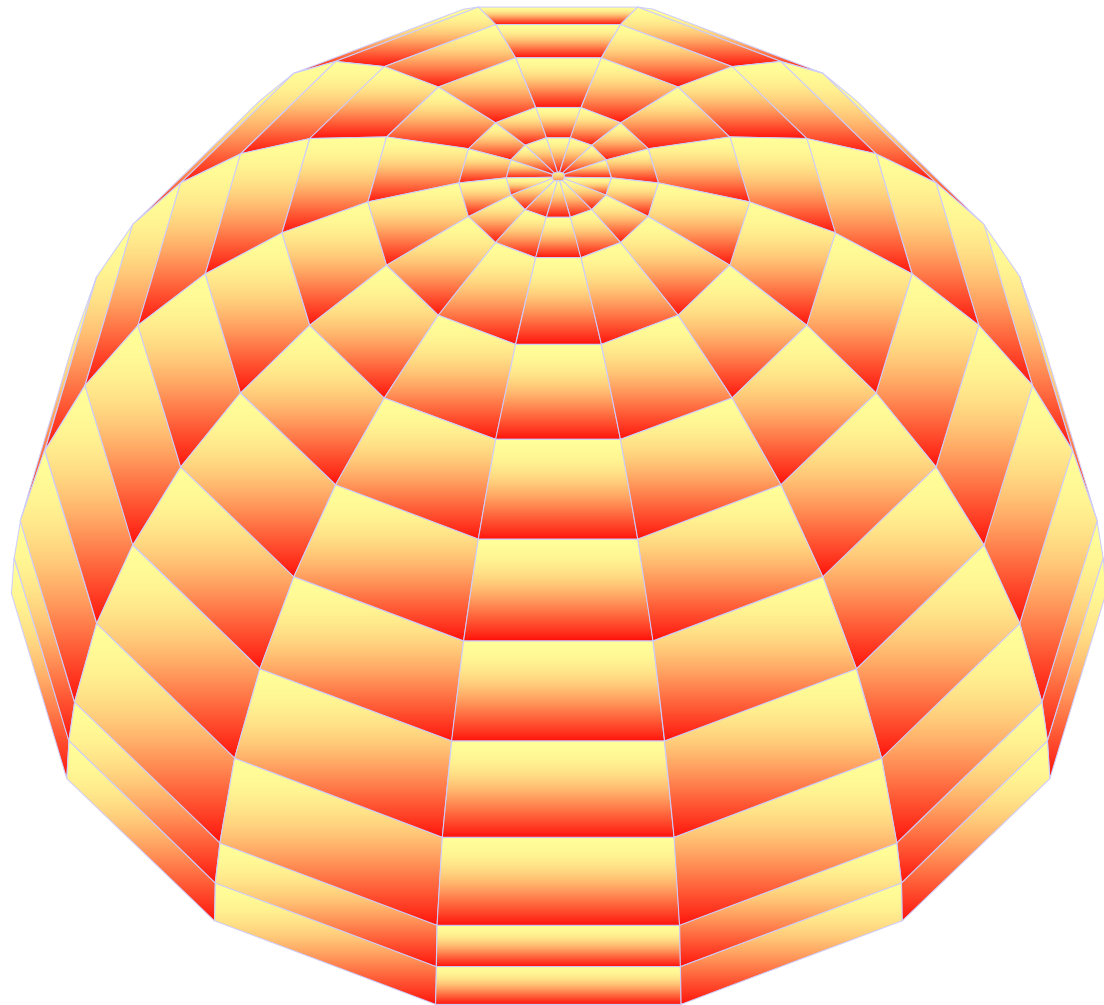

# HEALTH DOME

- If you were to say that one practice or solution stands out above and beyond all others at the pinnacle of the **Health Dome** then that would be:
- **Love and Forgiveness.**

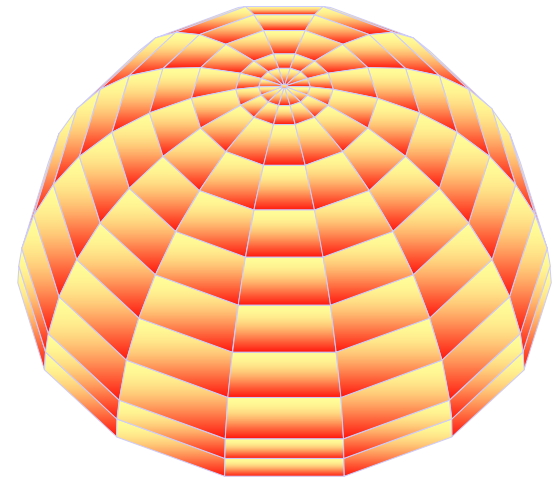

**“All dis-ease is mind generated, and all healing is generated by the love energy of one’s soul.”**

- **The errors / soul condition manifests illness. The lower ones level of consciousness then the more prevalent will be illness. Below the levels of 200, the ego dominates, however, as you raise your level of consciousness and achieve a level of 500 or higher, you start to transcend the ego. Above the level of 600, all healing is possible.**

**“All dis-ease is mind generated, and all healing is generated by the love energy of one’s soul.”**

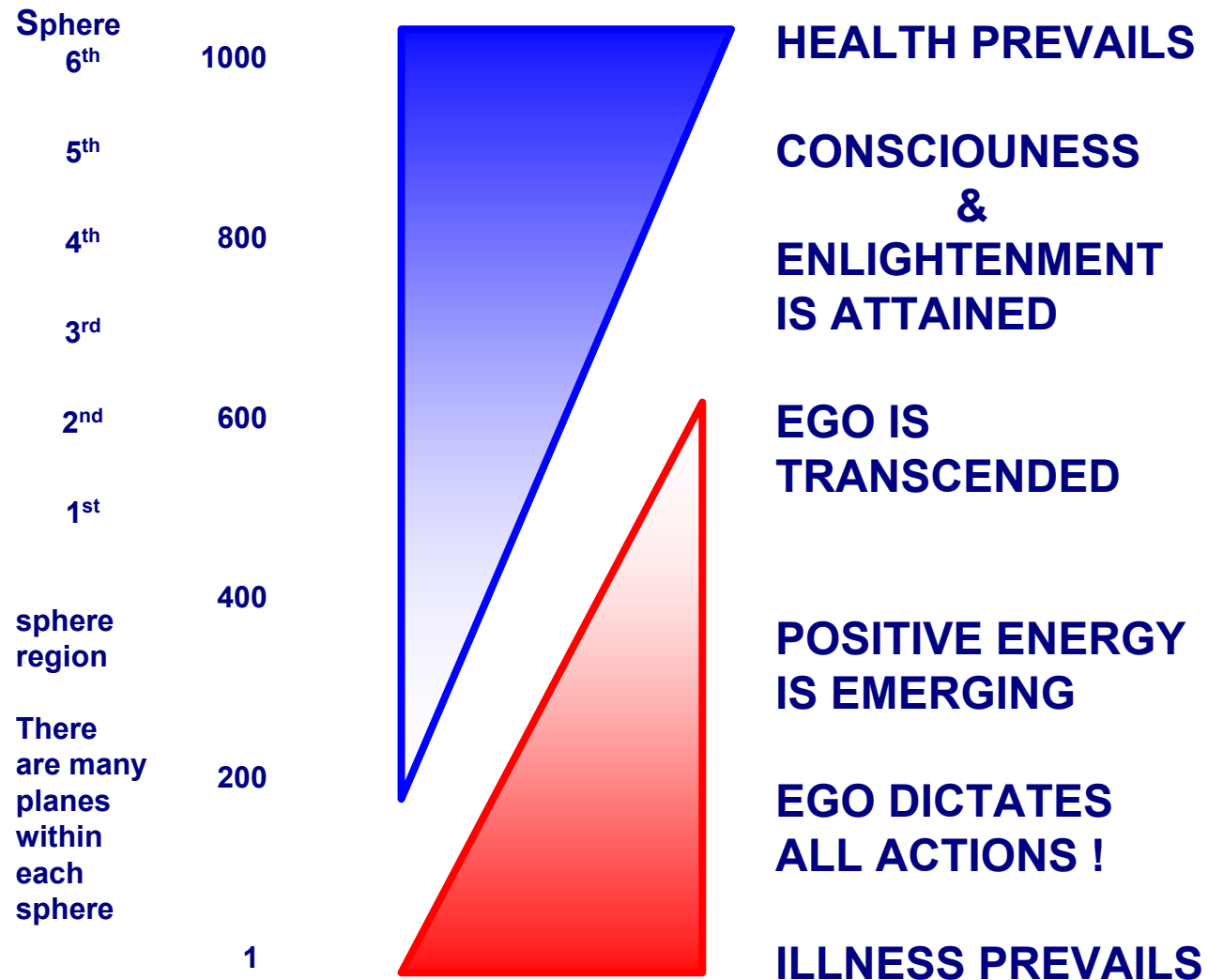

# Map of Consciousness

•Avatar	1000	
•Enlightenment	700	
•Peace	600	
•Joy	540	
•Love	500	POSITIVE
•Reason	400	ENERGY
•Acceptance	350	
•Willingness	310	
•Neutrality	250	
•Courage	200	NEUTRAL

# Map of Consciousness

•Courage	200	NEUTRAL
•Pride	175	
•Anger	150	
•Desire	125	
•Fear	100	
•Grief	75	NEGATIVE
•Apathy	50	ENERGY
•Guilt	30	
•Shame	20	
•Alive only	1	



# Map of Consciousness

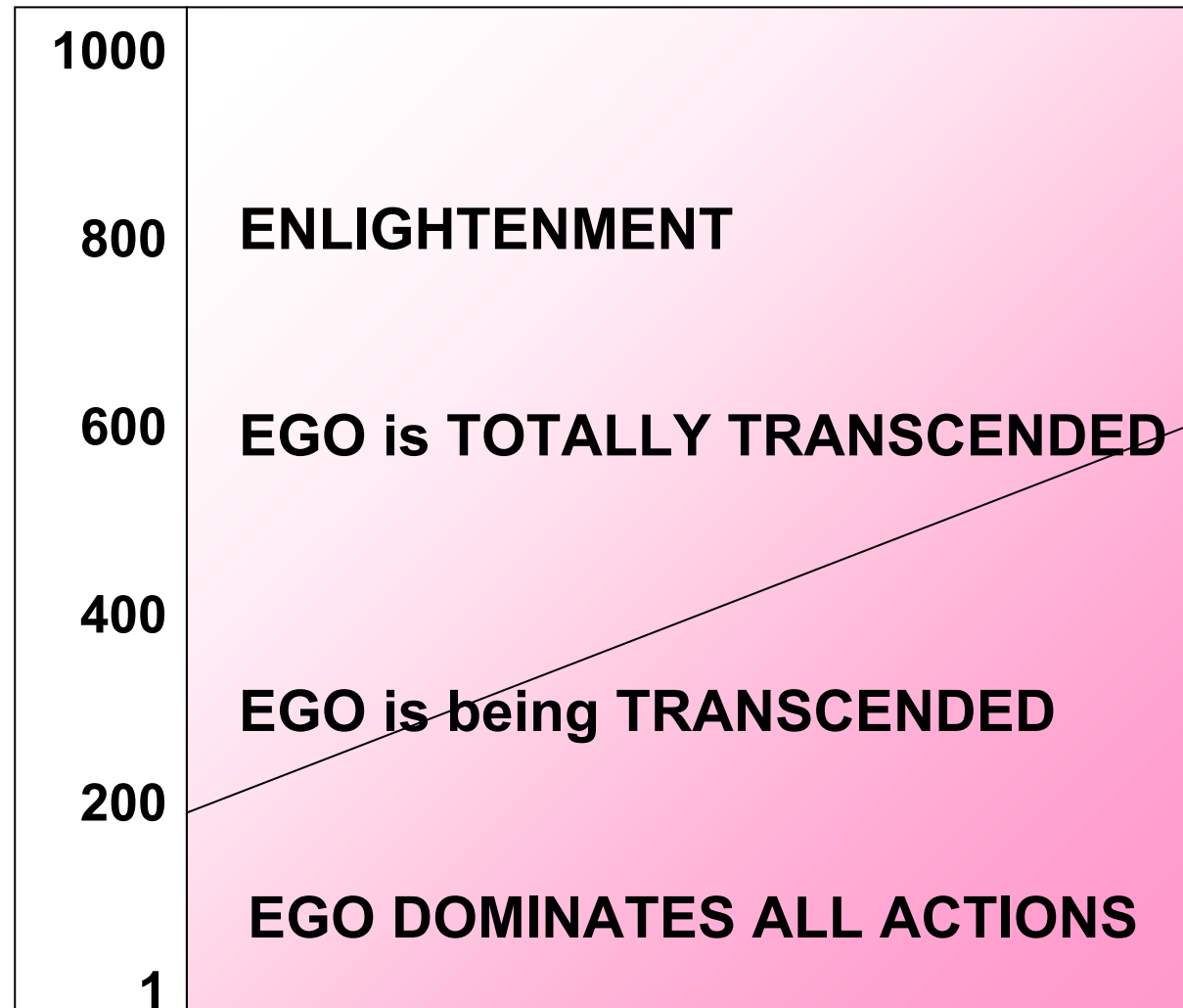

# **PASCAS CARE**

**SPIRITUAL**

**– NON DENOMINATIONAL –  
REALISATION**

**“The reason why we are here is to help  
and care for others.”**

**Consciousness  
Log**

1000

900

800

600

500

400

300

200

100

0

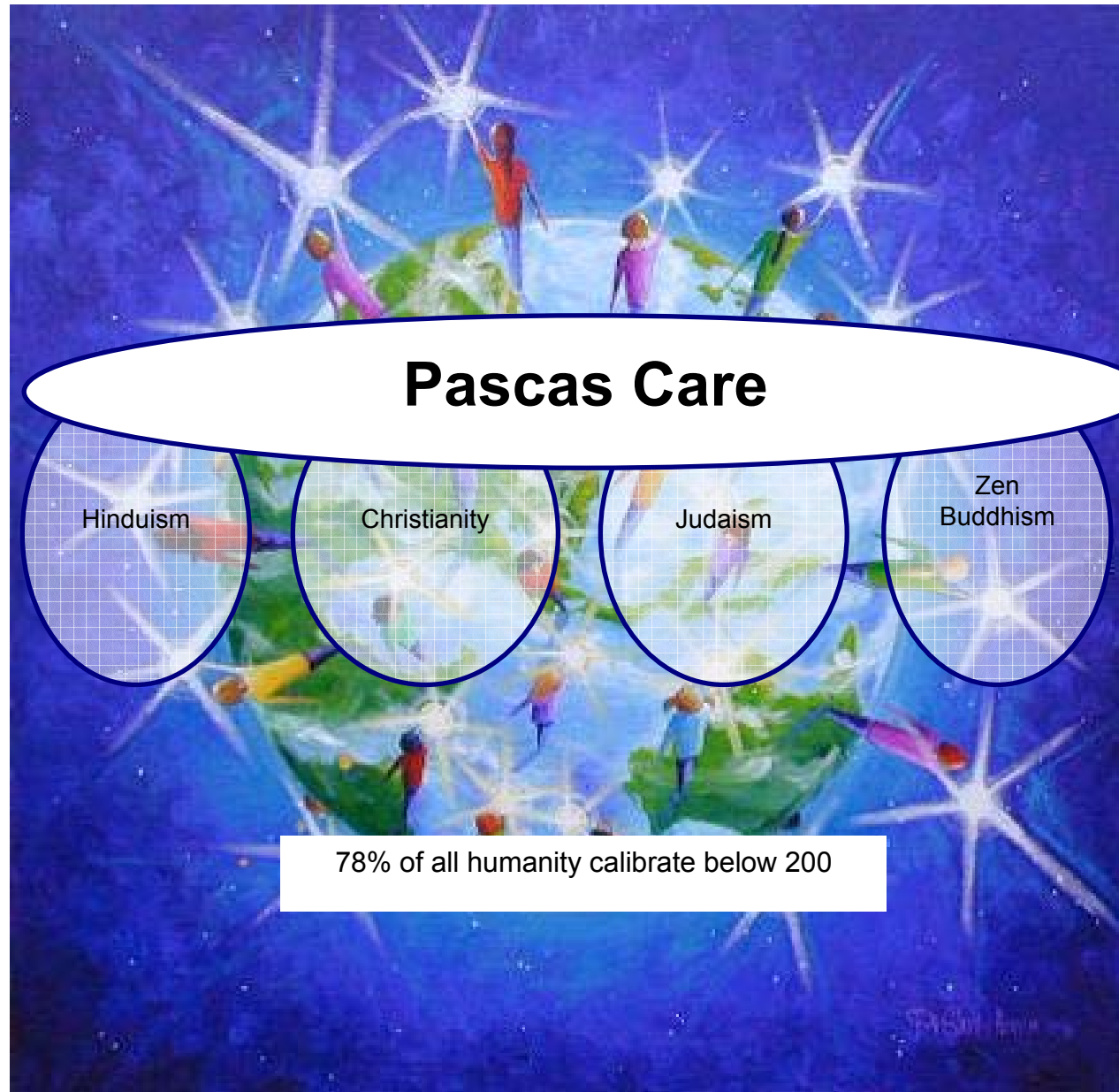

# The HEALTH MATRIX

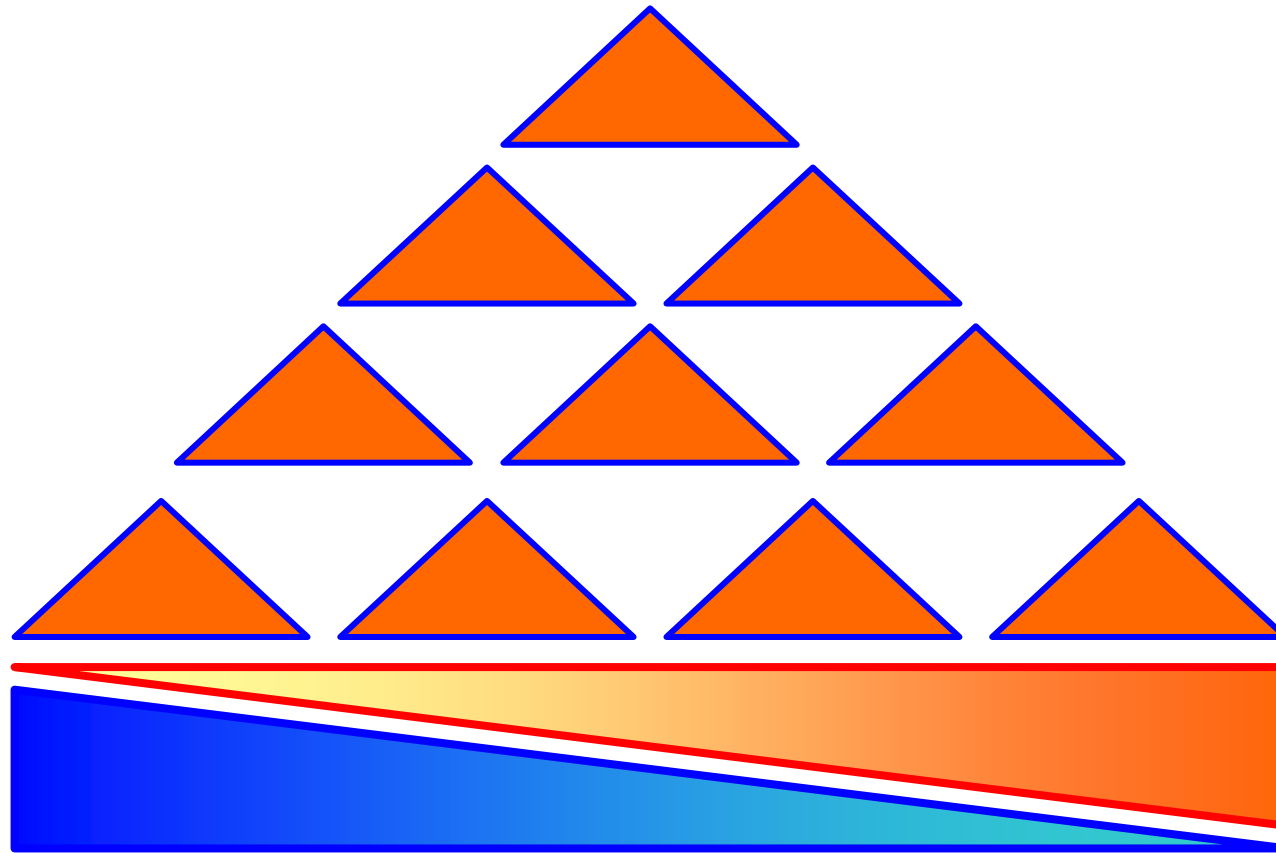

ALLOPATHY  
MEDICINE

COMPLEMENTARY  
THERAPY

'Pascas Care Centre'

# The HEALTH MATRIX

CLIENT / PATIENT	
MEDICAL HOLISTIC DIAGNOSTIC TECHNICIAN	
PROFESSIONAL MEDICAL TEAMS	COMPLEMENTARY THERAPY FIELDS
Neurosurgery	Complete Therapeutic Systems
Ears, Nose & Throat - ENT	Oriental Diagnosis
Urology	Western Diagnosis
Orthopaedic	Iridology
Trauma Surgery	Naturopathy
Gynaecology	Breathing
In-Vitro Fertilisation – IVF	Hydrotherapy
General Surgery	Food & Diet
Ophthalmic Surgery	Oriental Systems
Dental & Faciomaxillary Surgeons	Chinese Herbalism
Cardio Thoracic	Japanese Medicine
Oncology – Cancer	Ayurveda
Cardiology	Tibetan Medicine
Radiotherapy	Traditional Arabic Medicine
Medical Services	Shamanism
Imaging – X-ray – Ultrasound – CAT scan - MRI	
Pathology	
Streamer – Case Manager	

# The HEALTH MATRIX

Case management is assigned to a Diagnostic Streamer.

Patient interviews will typically be with all appropriate diagnostic technicians within one session.



**Streamer's Meeting**



## The Ten Human Body Systems:

1. Skeletal System
2. Muscular System
3. Circulatory System
4. Nervous System
5. Digestive System
6. Immune System
7. Urinary System
8. Reproductive System
9. Respiratory System
10. Lymphatic System

**"Our  
Physical  
Being"**



# "Our Physical Being"

# PASCAS CARE

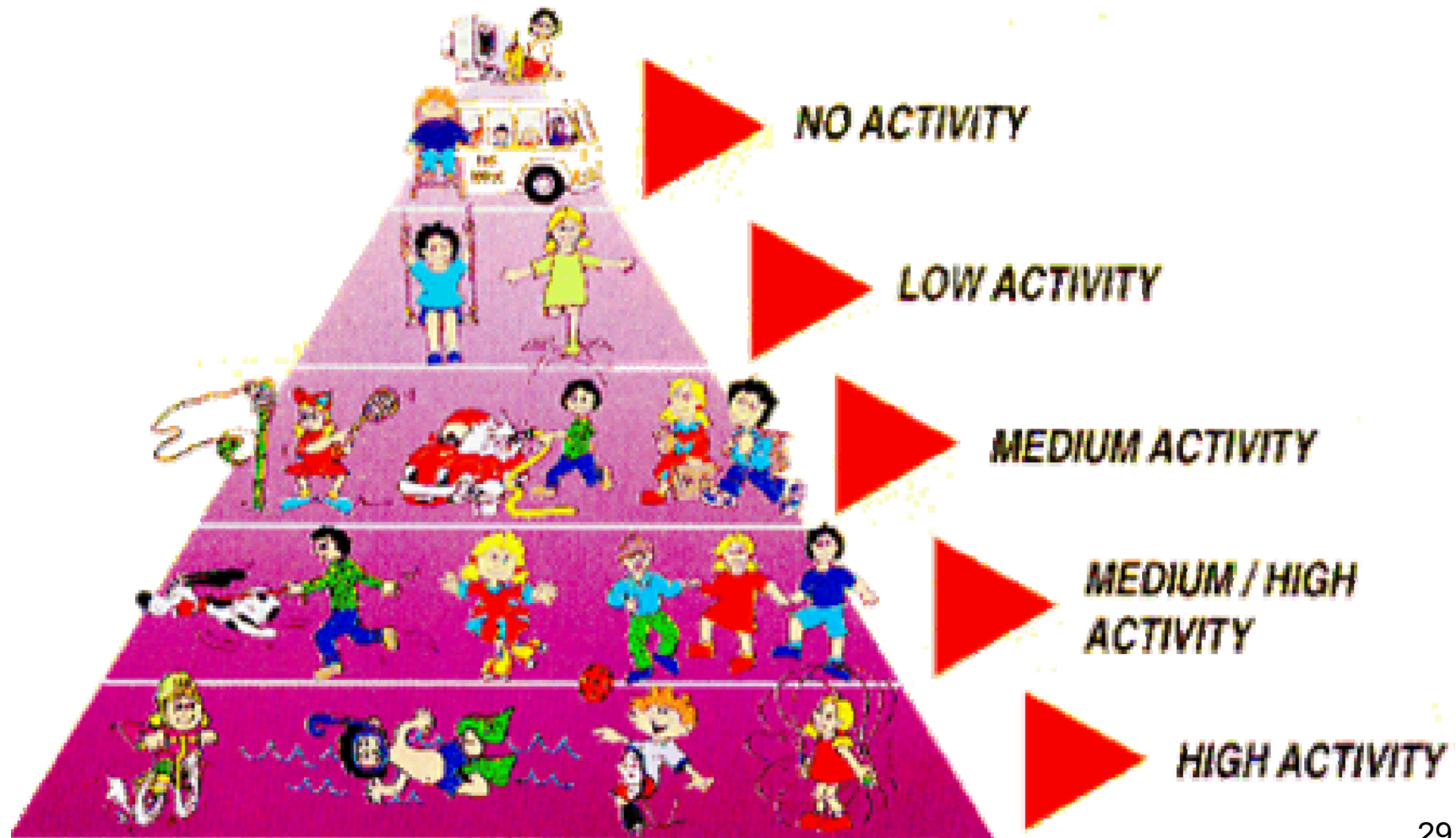

# PASCAS CARE

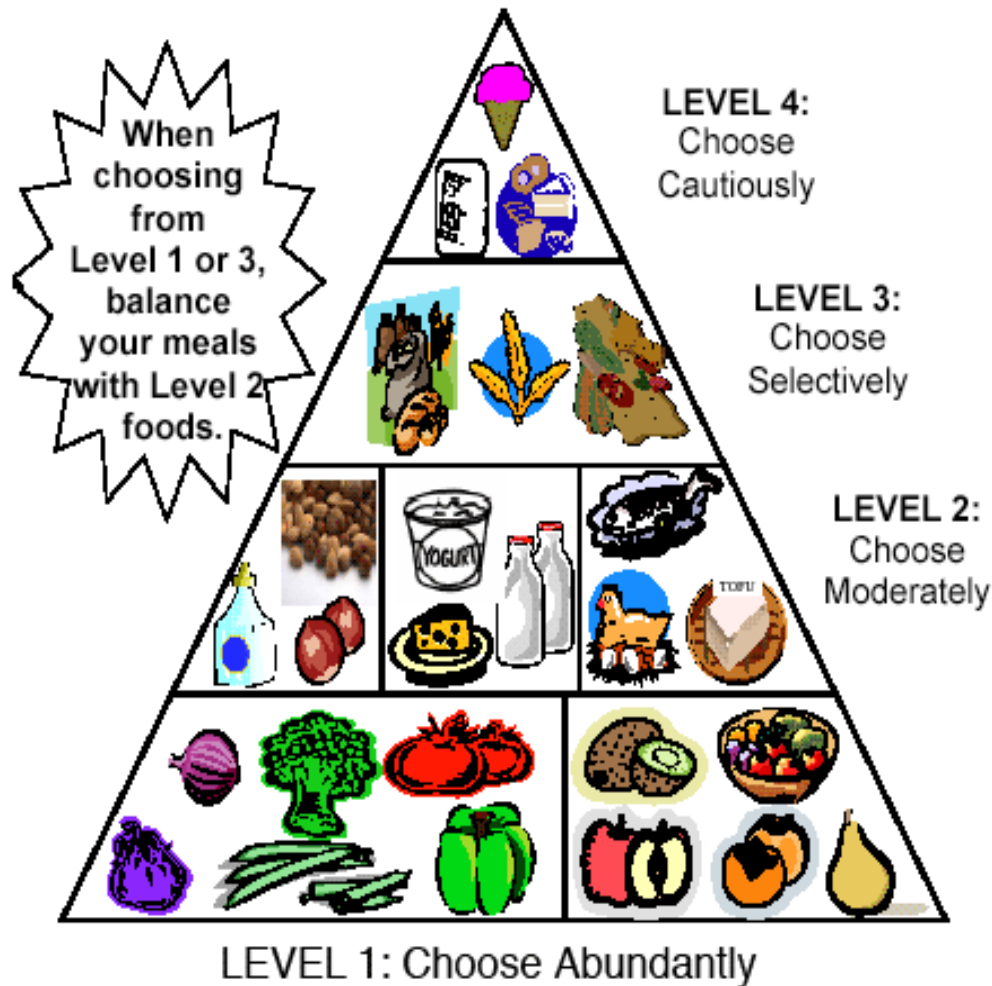

# Nutritional Content of a Well-Balanced Diet

# Function in the Body

Carbohydrates  
(330 g daily)

Main source of energy;  
fiber confers many health benefits.

Protein  
(100 g daily)

Major structural building blocks.

Fat  
(75 g daily)

Energy storage; synthesis  
and repair of cell parts.

Water  
(2000 g daily)

Solvent; lubricant; medium for  
transport and temperature regulation.

Vitamins  
(<300 mg daily)

Enable chemical reactions  
in the body.

Minerals  
(5-10 g daily)

Aid enzyme function; electrical balance;  
generate nerve impulses; bone structure.

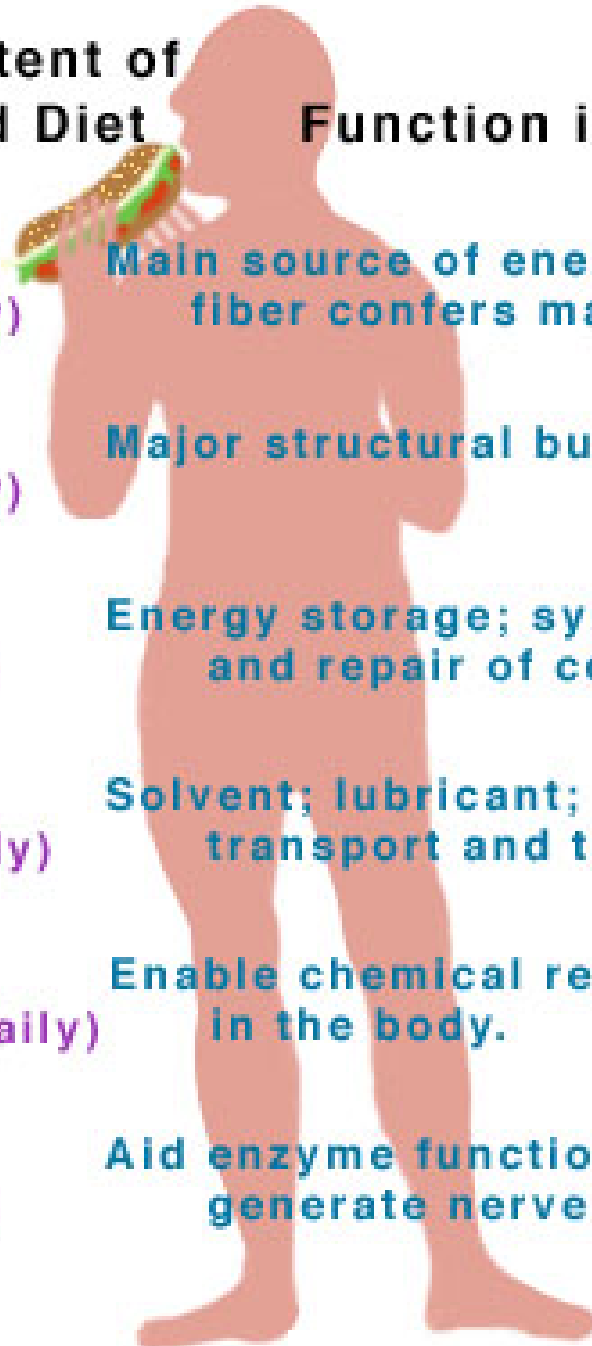

# Minerals - the vitamin carriers!

Periodic Table showing elemental range and typical detection limits for ICP-AES

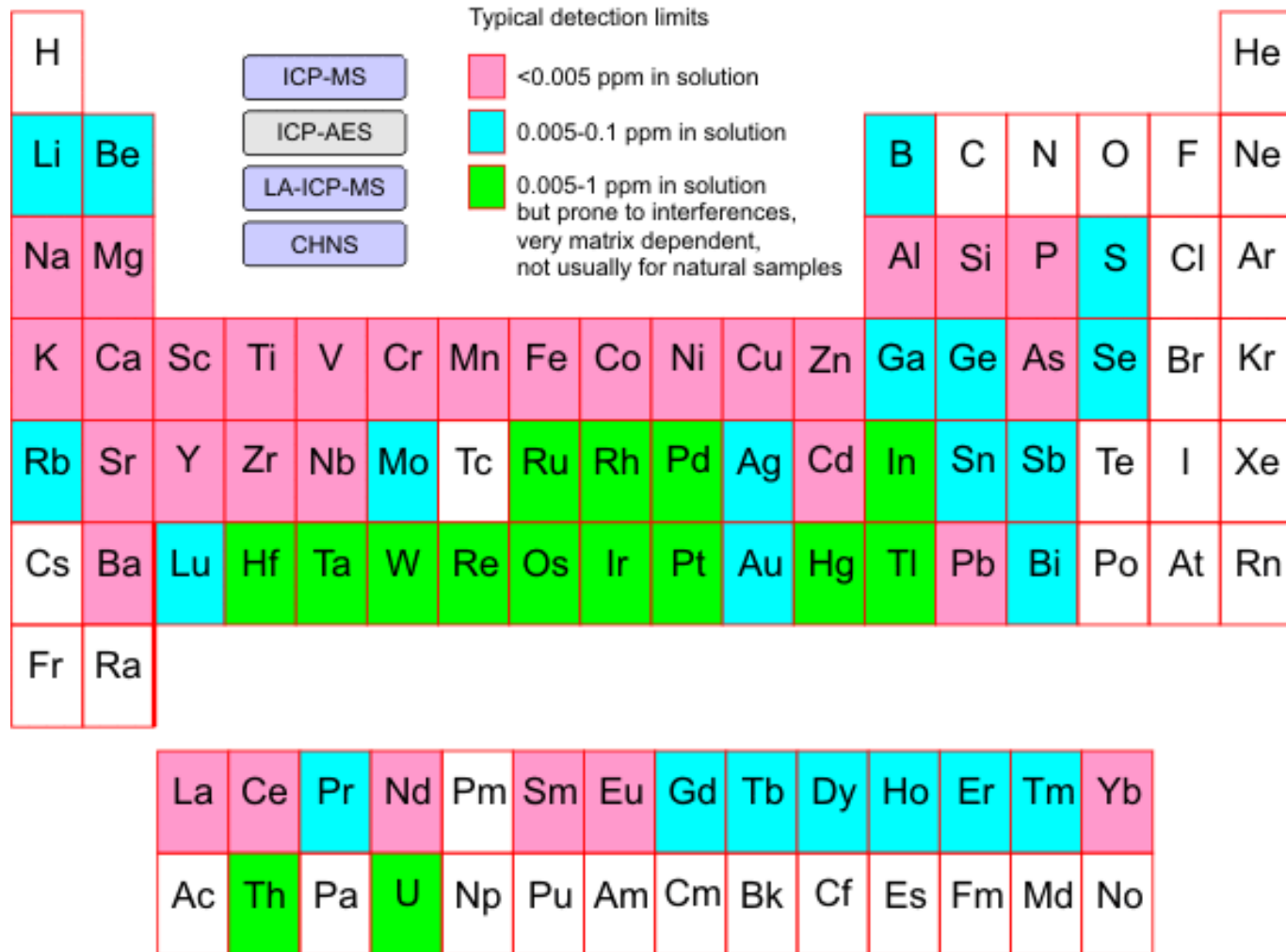



# Minerals - the vitamin carriers!

From one drop of blood TraceSmart determines all of your mineral levels with greater than 98% accuracy.



This enables your vitamin levels to be managed and your nutrition regime refined.

EXPECTED Vs MEASURED CONCENTRATION  
Matrix Doped With 200ng/g Multi-element Standard

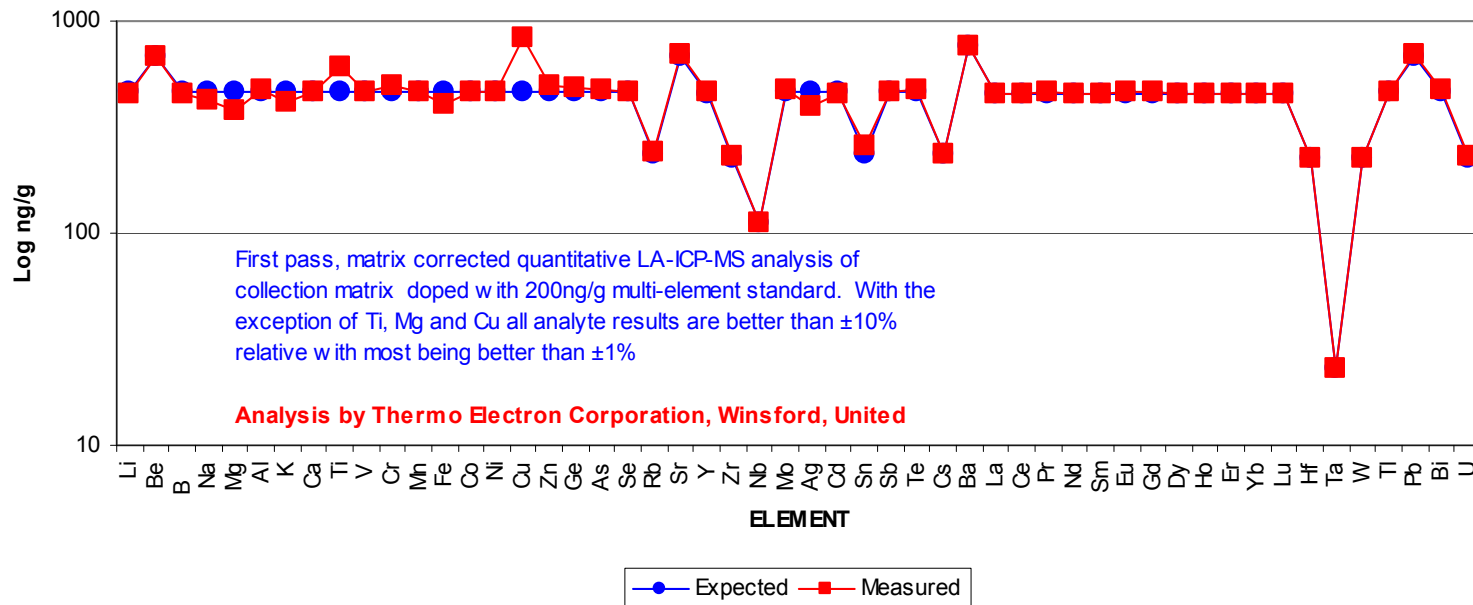

# *I want Vitamins!*



# PASCAS CARE

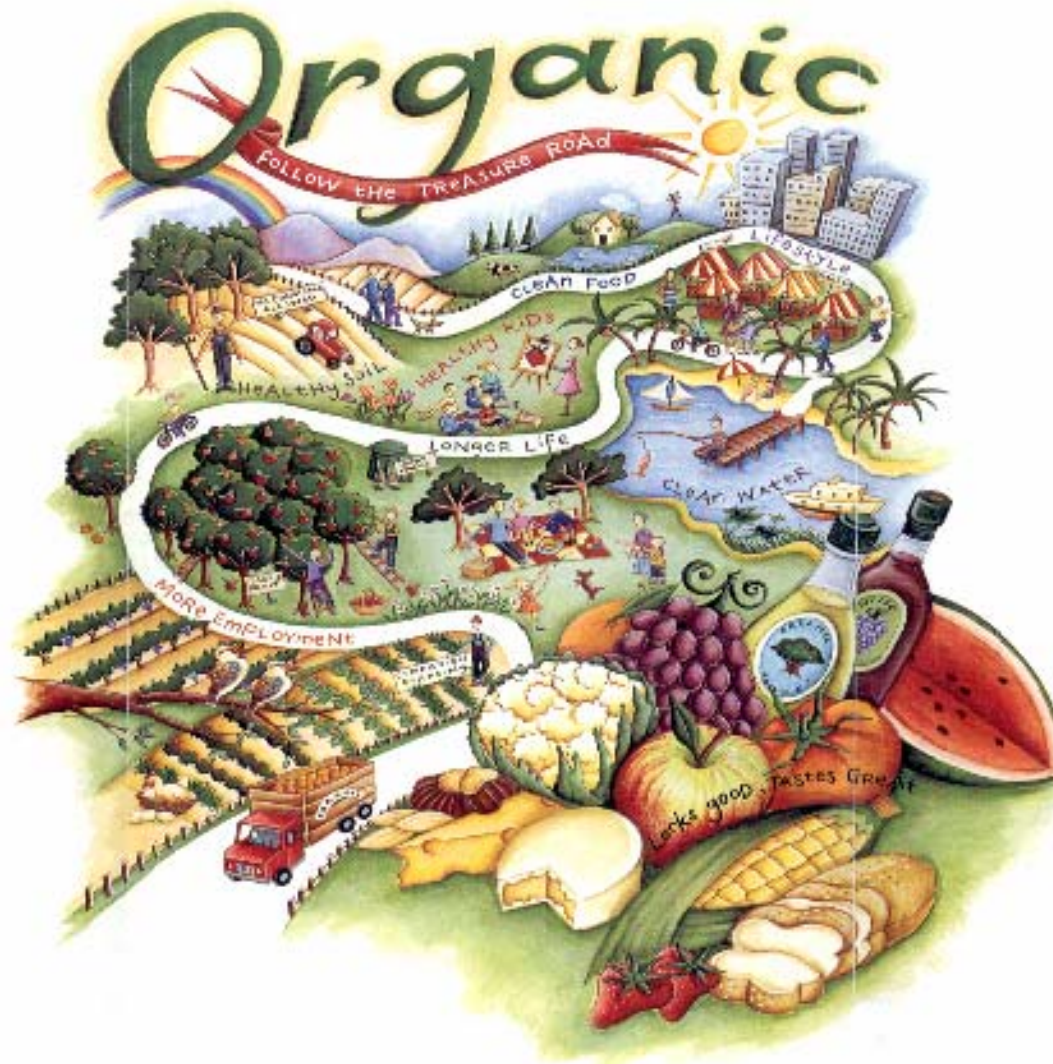

# PASCAS CARE

## NUTRITIONAL HEALING

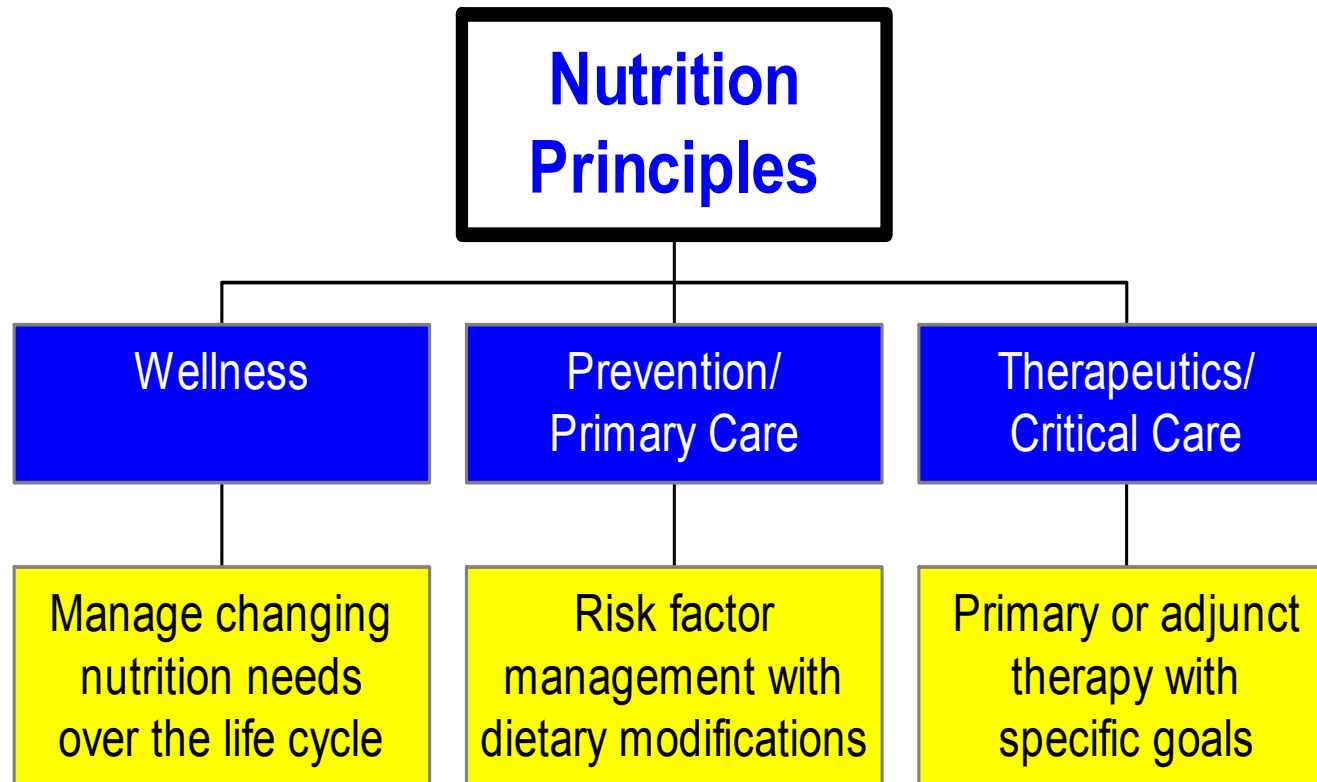



# NUTRITIONAL BIOCHEMISTRY

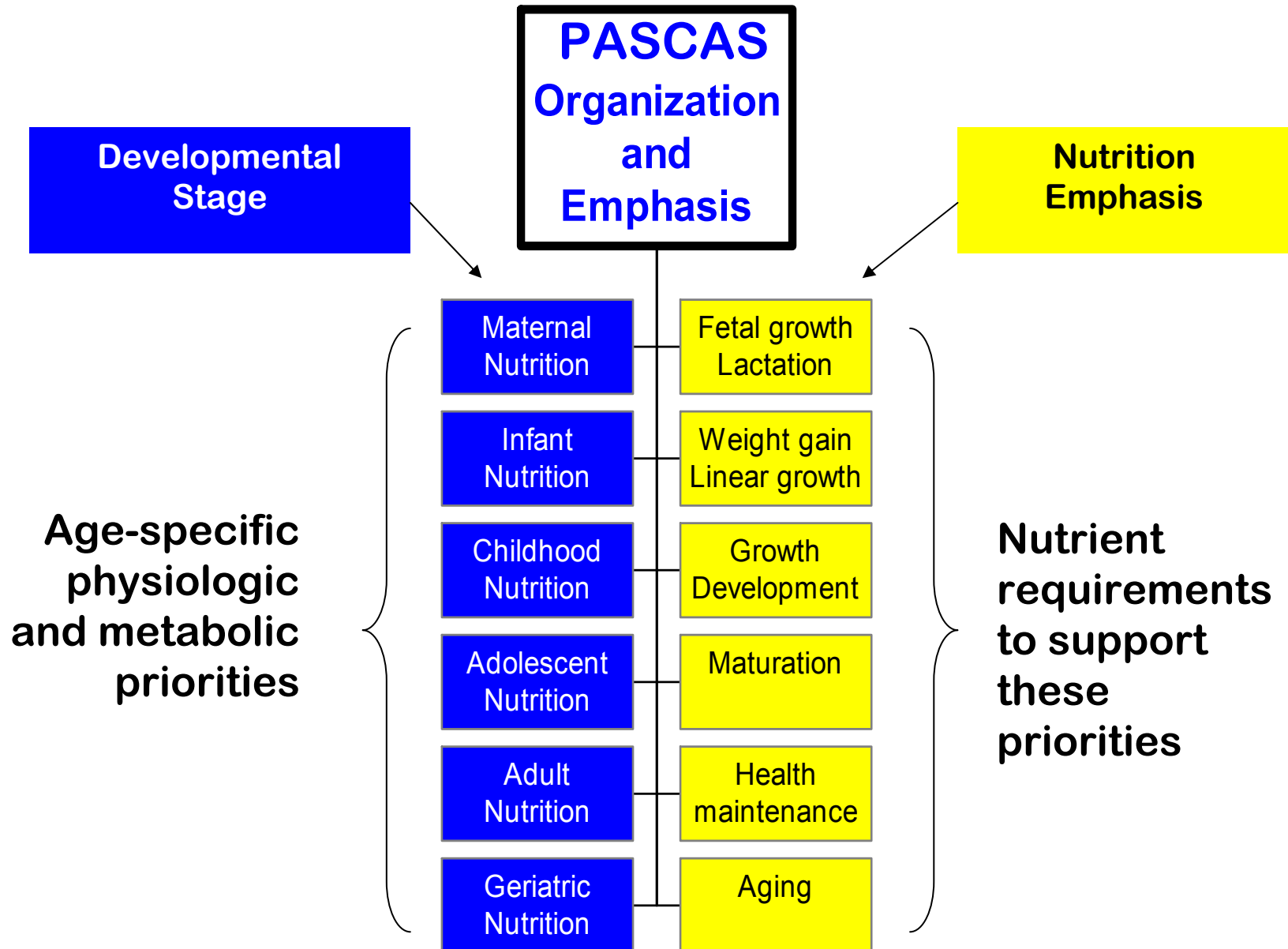

# ENVIRONMENTAL MEDICINE

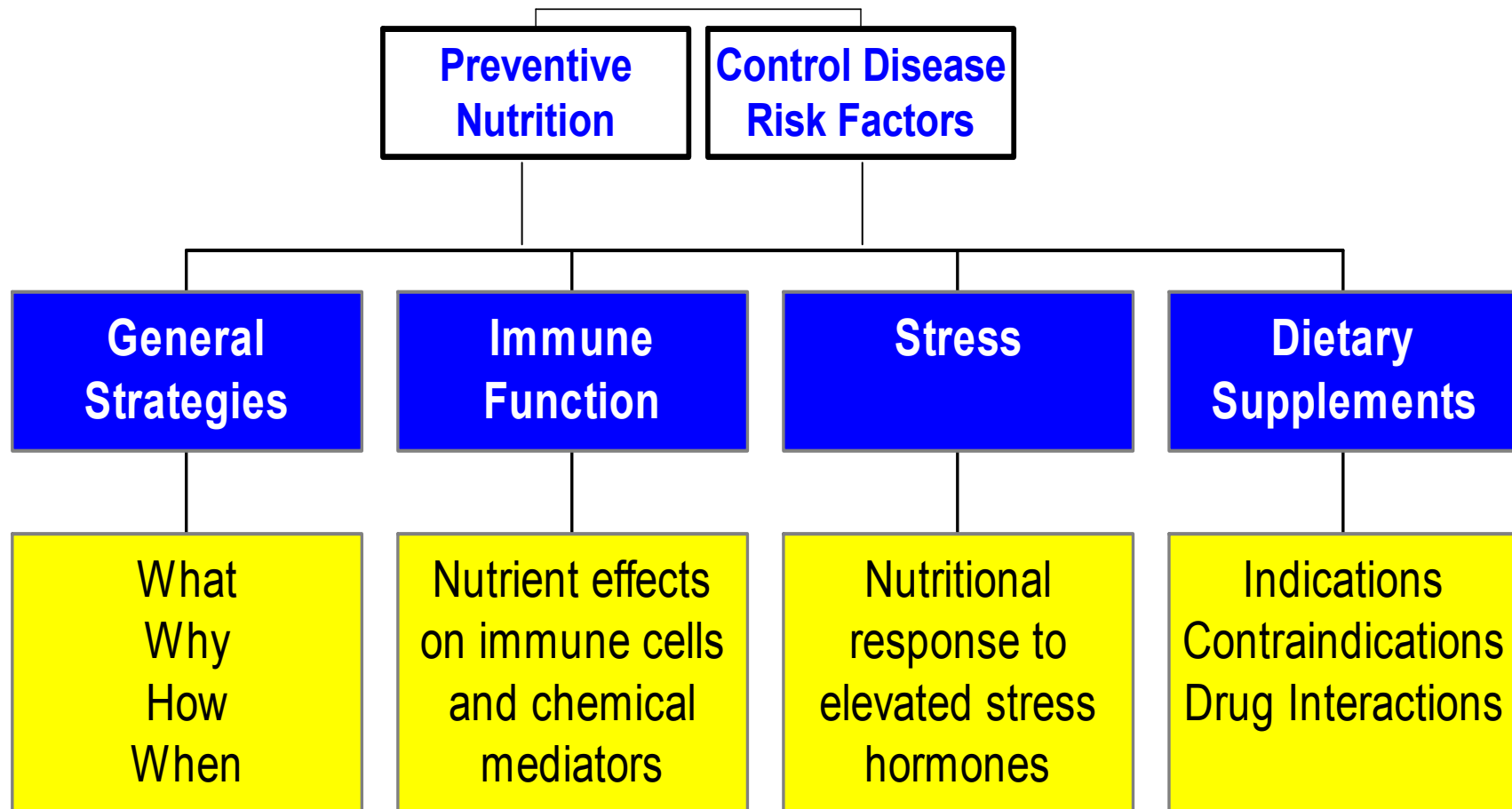

# PASCAS CARE

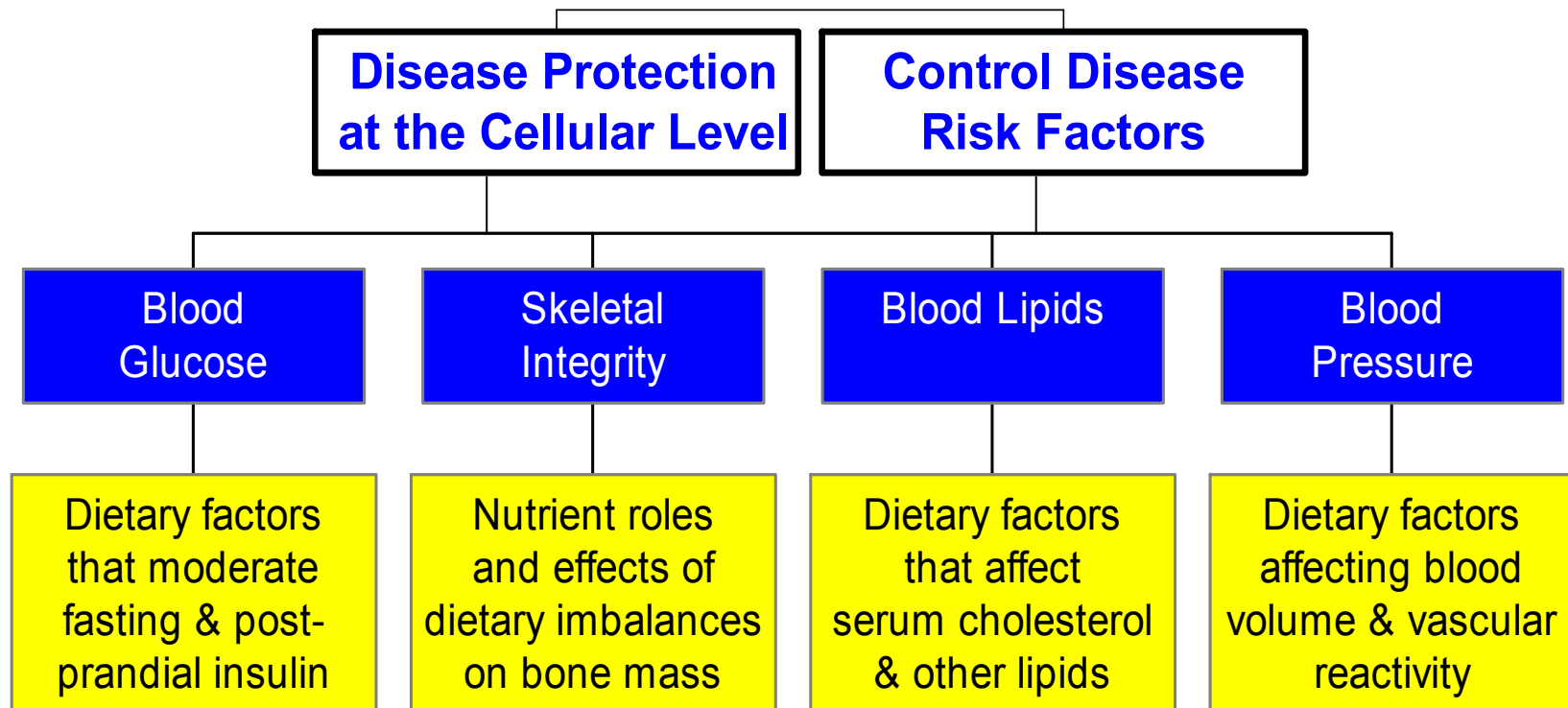

# OZONE BLOOD PURIFICATION





## **LIST of DISEASES that can be SUCCESSFULLY TREATED using OZONE**

Acne Rosacea	HIV
Arthritis	Hypercholesterolemia
AIDS	Internal Haemorrhaging
Alzimers	Irritable Colon
Anthrax	Japanese Encephalitics
Arthrosis	Joints
Asthma	Laryngitis
Athlete's Foot	Lesions
Bacterial Infections	Liver
Bed Sores	Liver Cancer
Bladder Infection	Lung infections
Brain Cancer	Lymphoma
Breast Cancer	Marburg Virus
Bronchial Asthma	Malaria
Burns	Menopause
Cardiovascular Diseases	Multi Sclerosis
Cerebral Cancer	Muscle Cramps
Chronic Fatigue Syndrome	Mycosis
Cirrhosis of the Liver	Optic Nerve Disorders
Circulatory Disturbance (arterial)	Orthopaedics
Circulatory Disturbance (venous)	Osteomyelitis
Climacterium	Parasitical Infections
Cold & Flu Virus	Parkinson's
ETC	ETC

# MAGNACARE & DIAPULSE

## in 9 days!

### HAND INJURY

Patient: 54 year old male

Hand was caught in metal working machine causing destruction of tissue and double fracture of the thumb and index finger.



Surgery performed two (2) hours after accident. Fractures were reduced and wounded tissue was closed with 35 sutures.

therapy was instituted three (3) times a day for nine (9) days. Treatments began immediately after surgery.



There was no analgesic required during the entire nine day period.



# PEHRG214

- **Corporation's patented technology enables it to grow antibodies to kill HIV, and potentially other viruses such as SARS, Anthrax, West Nile Virus and Dengue Fever in humans.**



# ProCell Corporation

**All products will be able to be taken by mucosal administration (drinking, eating, inhaling).**

Employing plant production, cost of vaccines produced will be reduced to between 100th to 1,000th in cost.

Vaccines include:

- Nerve Agent Antidote – Butyrylcholinesterase – (BCHe).
- Edible human immunodeficiency virus (HIV) Vaccine (for developing countries).
- HIV p24-based viral load assay.
- HIV and any viral protein components, being plant derivatives, for production of vaccines and for diagnostics.

# MORINGA = Edible Vaccines

**Moringa oleifera seed = Edible HIV Vaccine**



# MORINGA = Nutrition



GRAM FOR GRAM  
**MORINGA**  
LEAVES CONTAIN:



**7 TIMES** THE VITAMIN C  
FOUND IN ORANGES



**4 TIMES** THE CALCIUM &  
**2 TIMES** THE PROTEIN  
FOUND IN MILK



**4 TIMES** THE VITAMIN A  
FOUND IN CARROTS

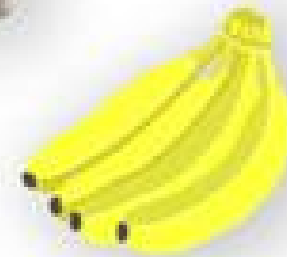

**3 TIMES** THE POTASSIUM  
FOUND IN BANANAS

# MORINGA = Water Purification





# PASCAS CARE

## *Junior Journey*

Using The Journey with kids is a practical and effortless way to help children clear personal issues, liberate the innate genius within, allow natural abilities to shine and their spirits to soar. The results kids experience are as profound and deep as with adults attending The Journey Intensive programs.





# ChildSOS

**Childhelp USA®** exists to meet the physical, emotional, educational, and spiritual needs of abused and neglected children. They do so by focusing our efforts in the areas of treatment, prevention, and research.



# PASCAS CARE

## TRUE PRAYER

WHEN  
THREE  
BECOME  
ONE

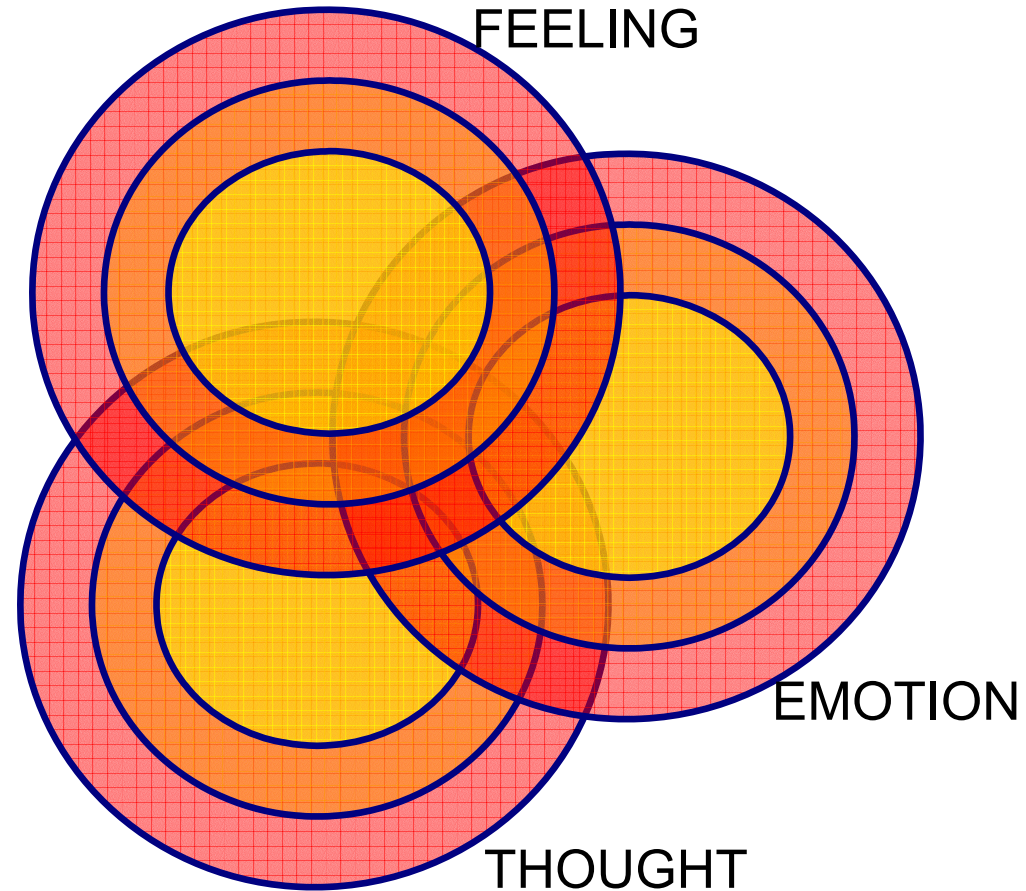

Thought, feeling, and emotion as unaligned patterns.  
In the absence of union, they may lose their focus.

# PASCAS CARE

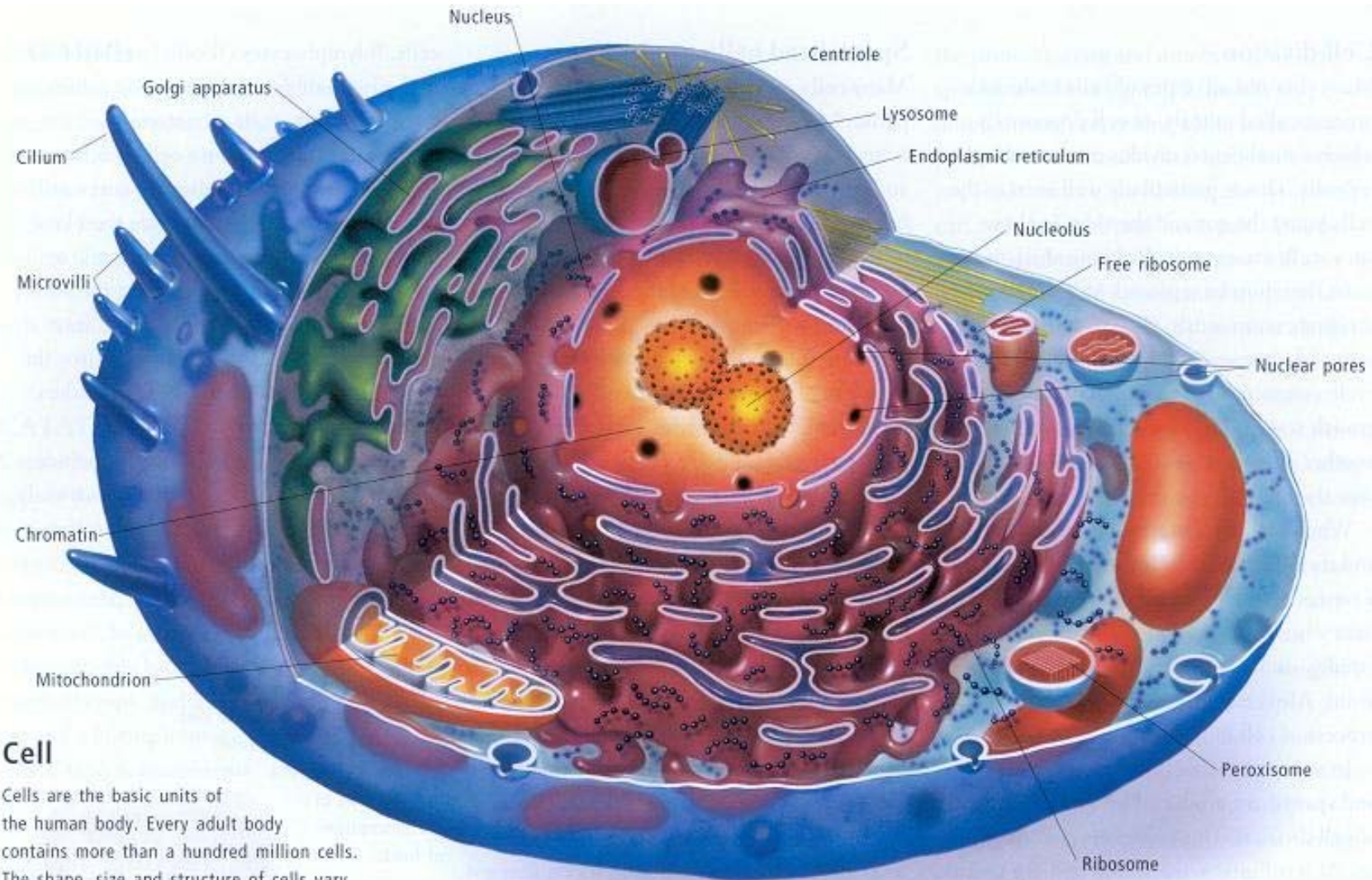

## Cell

Cells are the basic units of the human body. Every adult body contains more than a hundred million cells. The shape, size and structure of cells vary according to their functions within the body.

# PASCAS CARE

Humanities possible evolution from a Carbon based DNA to a Crystalline DNA is resulting in profound developments at an astonishing rate.

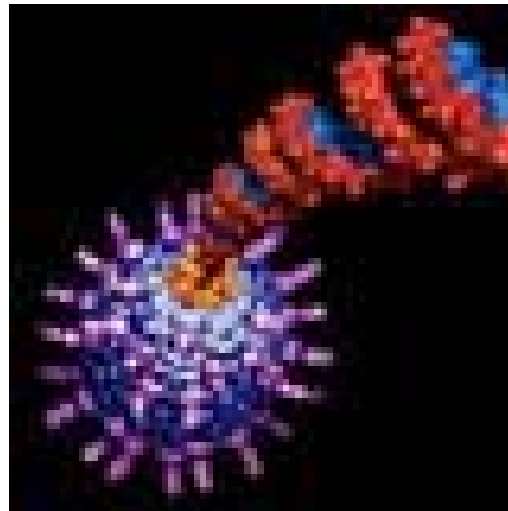

# PASCAS CARE

- The challenge now confronting us is to integrate the monumental cellular changes occurring within every being on the planet with the reality of everyday living and health.
- Health techniques that are feeling-based will produce often-instantaneous results.
- Vibration medicine will replace the traditional techniques in present practice.
- Light body health sciences are evolving.



# PASCAS CARE

- Technical schooling will come to serve as a footnote to an emerging population of our beings gifted with healing abilities they oftentimes do not understand.
- These folks will teach the techniques of purification to beings presently coming into form in far more complex physical bodies.
- The purification of one's physical form is the single most significant activity you may choose to focus your energies.

# PASCAS CARE

- The use of herbal medicines as practiced by certain indigenous cultures may have the effect of accelerating the cleansing process.
- Substances whose sole purpose is to **mask** symptoms and provide a false sense of well-being are counter productive and are therefore potentially dangerous.
- Correlation between one's thoughts and emotions **is** a predeterminant to the state of one's physical health.

# PASCAS CARE

- Vibrational / energy therapy is able to address “predisposition” to certain states of being.
- That predisposition is carried forth in one’s cellular structure and manifests when accumulated vibrational toxins reach levels that result in physical symptoms.
- An individual carries residual emotional baggage, imprinted in the cellular structure.
- Raising one’s vibration / consciousness, can do much to alleviate conditions that one was predisposed to manifest.



# PASCAS CARE

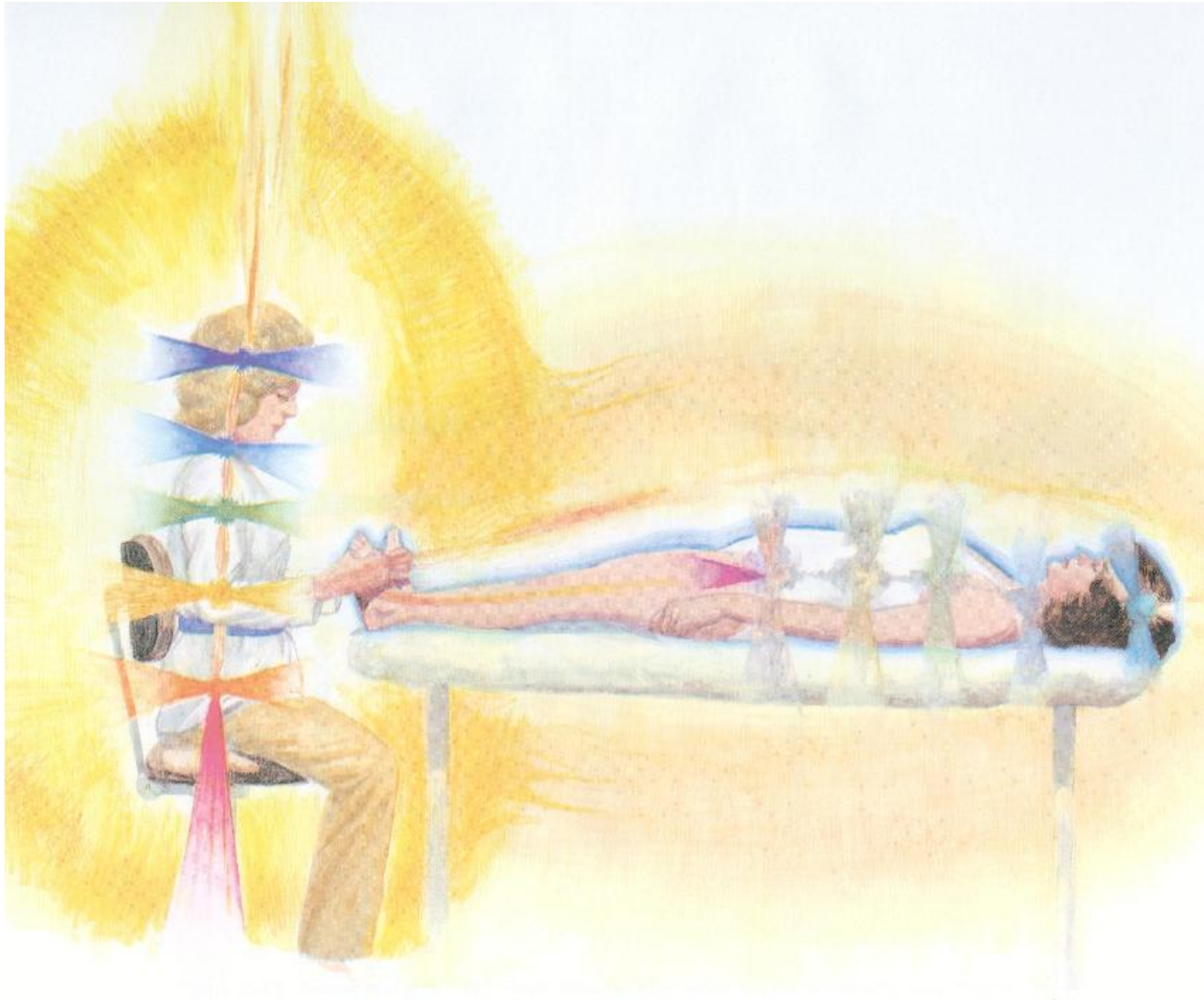

Balancing Auric Field of Patient, Healer and  
Universal Energy Field

# PASCAS CARE



Hands of Light

# PASCAS CARE

## PRANIC HEALING





# PASCAS CARE

## Energy Enhancement System

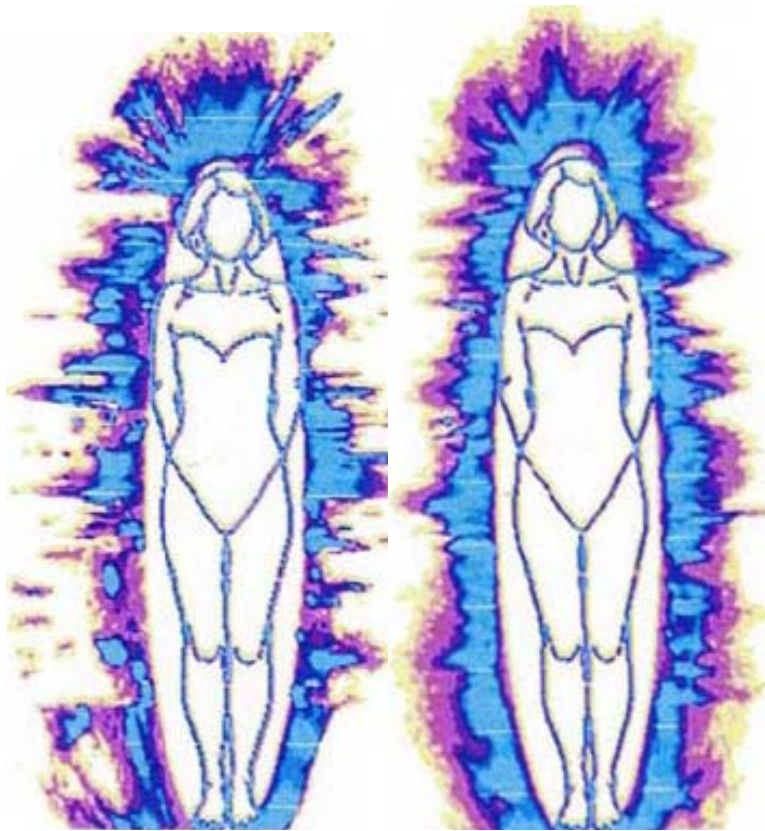

BEFORE

AFTER



# PASCAS CARE

Nutri-Energetic Systems©

Like Free Stuff?

Go to

**XWINNER.COM**

Win Prizes, Giveaways  
Sweepstakes & More!

Like Free Stuff?

Go to

**XWINNER.COM**

Win Prizes, Giveaways  
Sweepstakes & More!

# "Our Being"

First of the SEVEN LAYERS of the AURA (Spirit Body)

**Ketheric Template Body – Causal Body – Divine Knowing –**

↑ **Spiritual Body**

**Celestial Body – Divine Loving**

↑

**Etheric Template Body – Divine Will**

↑

**Astral Body – Loving – Relations with Others**

↑

**Mental Body (very active mind, consciousness and domain of the ego) – Rational Mind**

↑

**Emotional Body – Real Feeling**

↑

**Etheric Body (incorporates Chakras) – I Exist – Spirit Body**

↑

**Physical Body (including the brain) - Beingness**

# "Our Being"

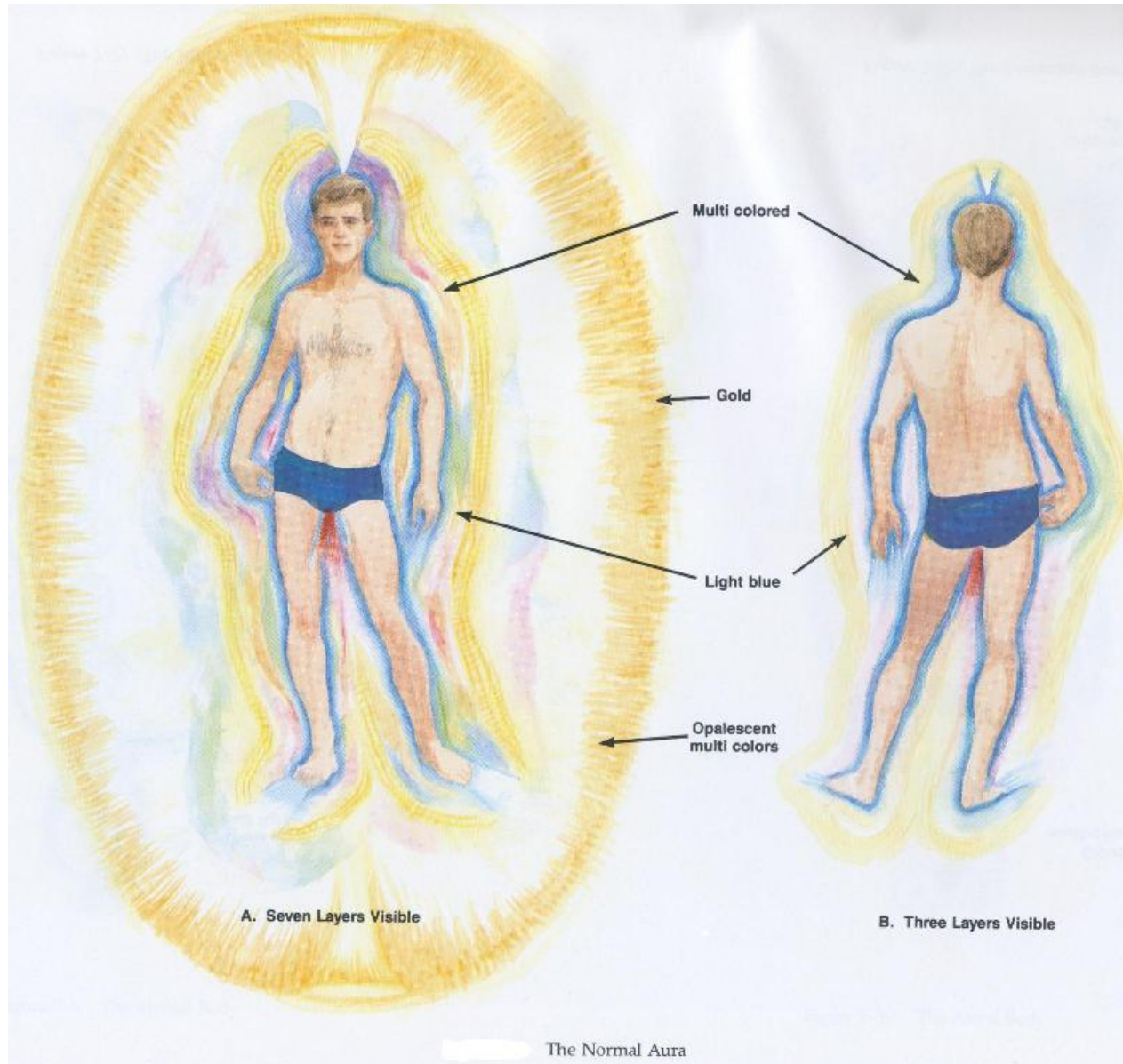



# "Our Being"

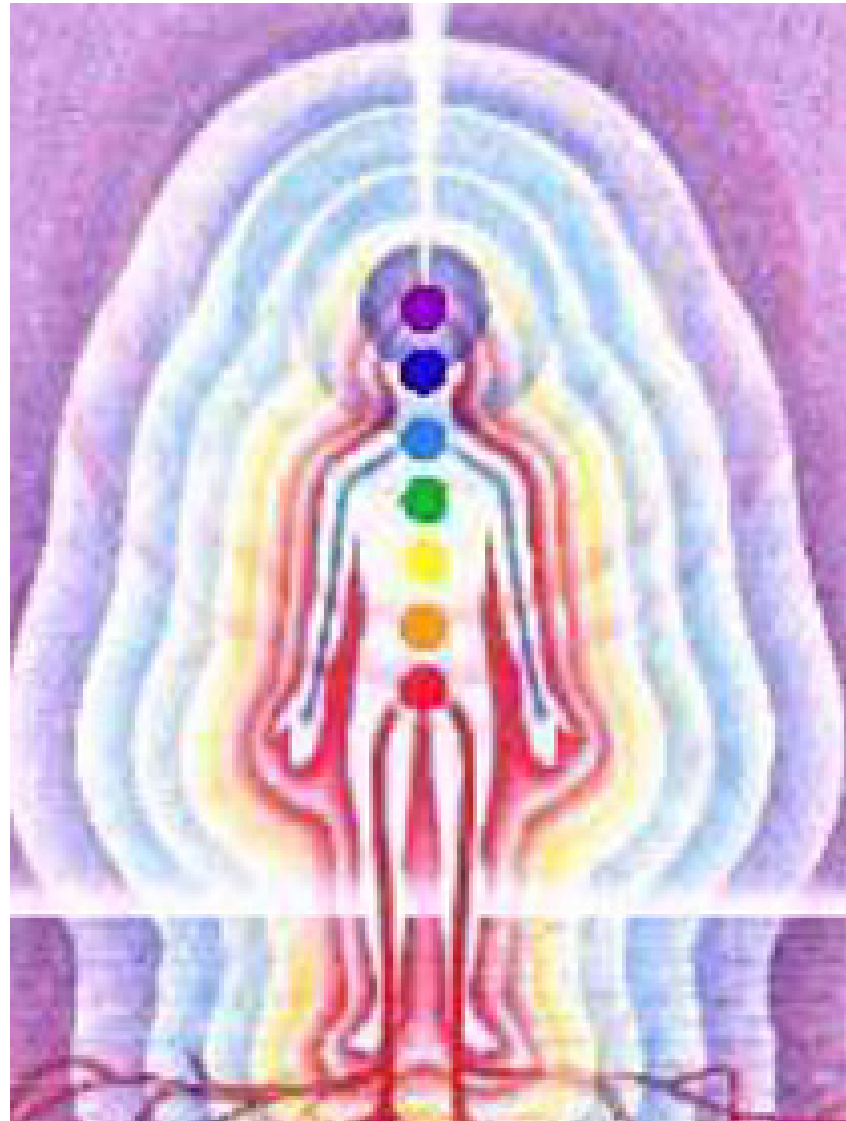

# "Our Being"

## Hara of a Healthy Person



# "Our Being"

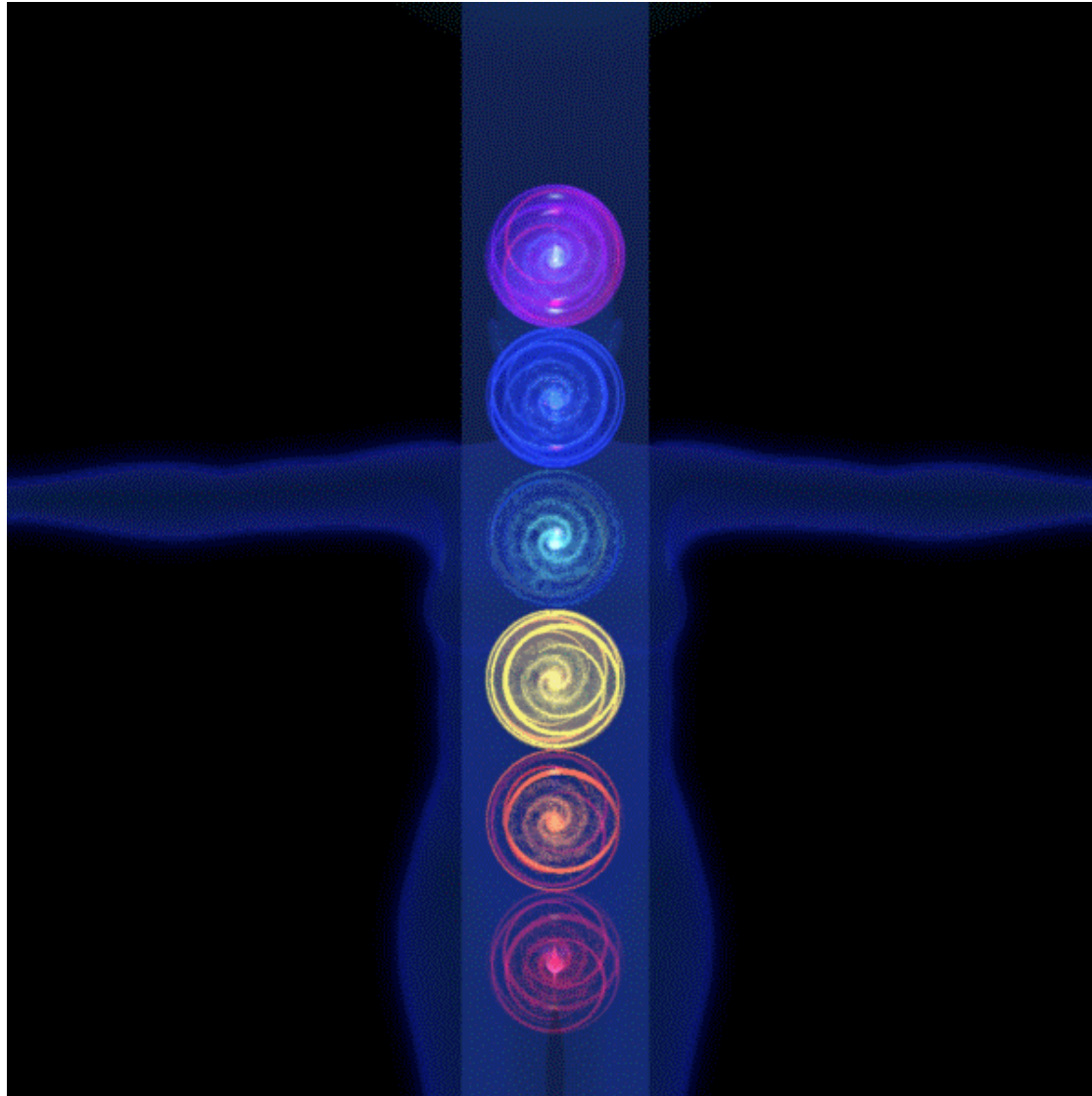

# PASCAS CARE CENTRE

A PASCAS CARE Centre has three elements:

- Front end medical centre and clinic.
- Day treatment facility for delivery of healing programs for HIV/AIDS, TB, Malaria, etc.
- Nutritional training, welfare programs and introduction to new income pathways.

# PASCAS CARE CENTRE

<p><b>PASCAS</b></p>	<p><b>Pascas Cafe</b> <i>with</i> <b>Raw Power!</b></p>
<p><b>CARE</b></p>	<p><b>CHALDI</b></p>
<p><b>CENTRE</b></p>	<p><b>COLLEGE</b></p>

# PASCAS CARE CENTRE

Medical Clinic  
Consultations  
Day Care  
Treatment



**Average number of employees per clinic including medicos: 25**  
**day care treatment facility: 20**  
**nutrition café and community services: 15**  
**Total: 60**



# PASCAS HEALTH CLINIC



**Locations within 5 to 10 years: 4,000 sites**  
**Africas 730, Sub-Continent 900,**  
**Pacific Basin 640, South Americas 840,**  
**Central Americas 490, US Indian Nations 400.**



# Training & Education



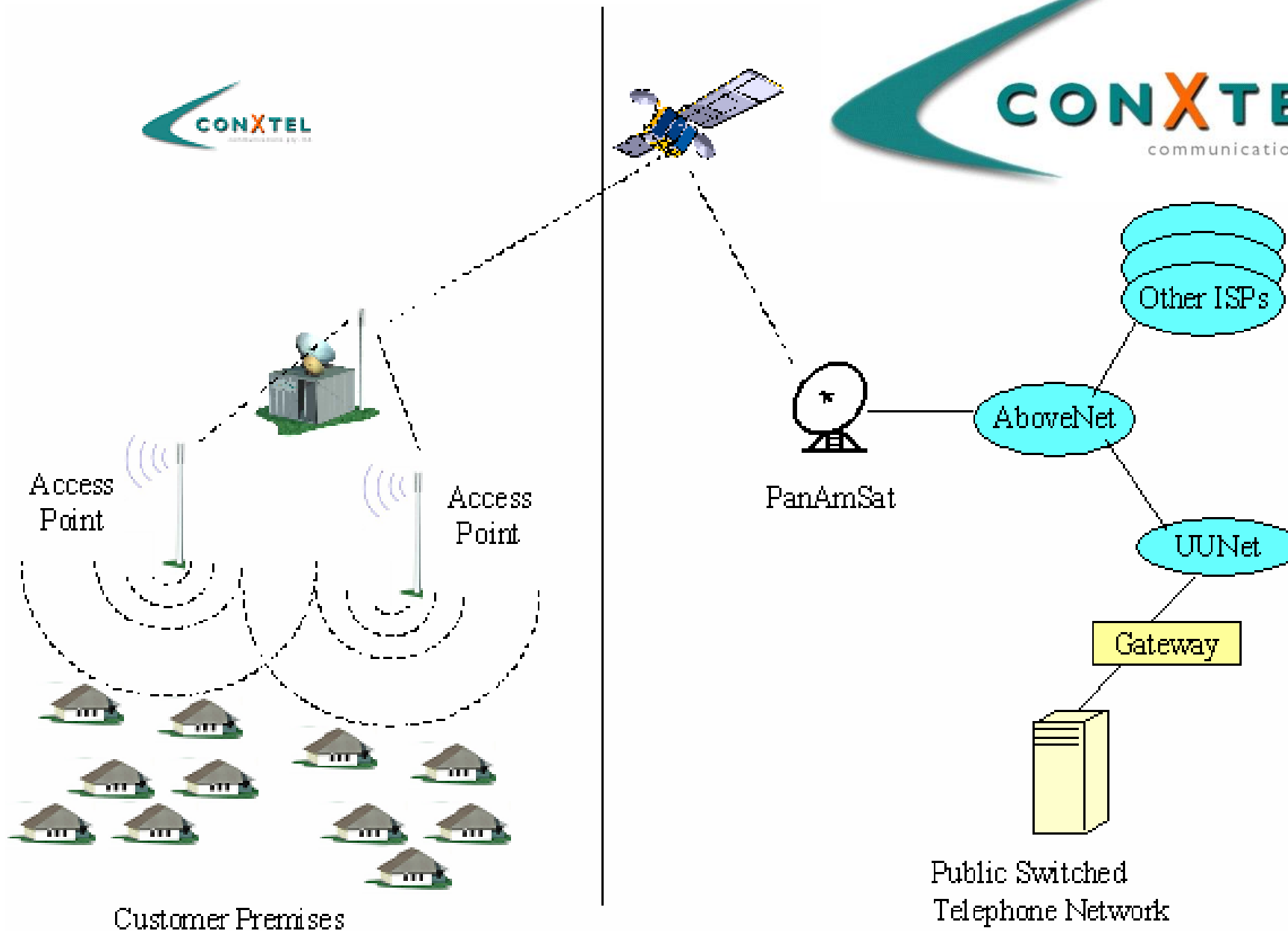

# EDUCATION DYNAMICS

## Chaldi College

**Symbolically, the iceberg is a good representation of the undiscovered potential in all of us.**

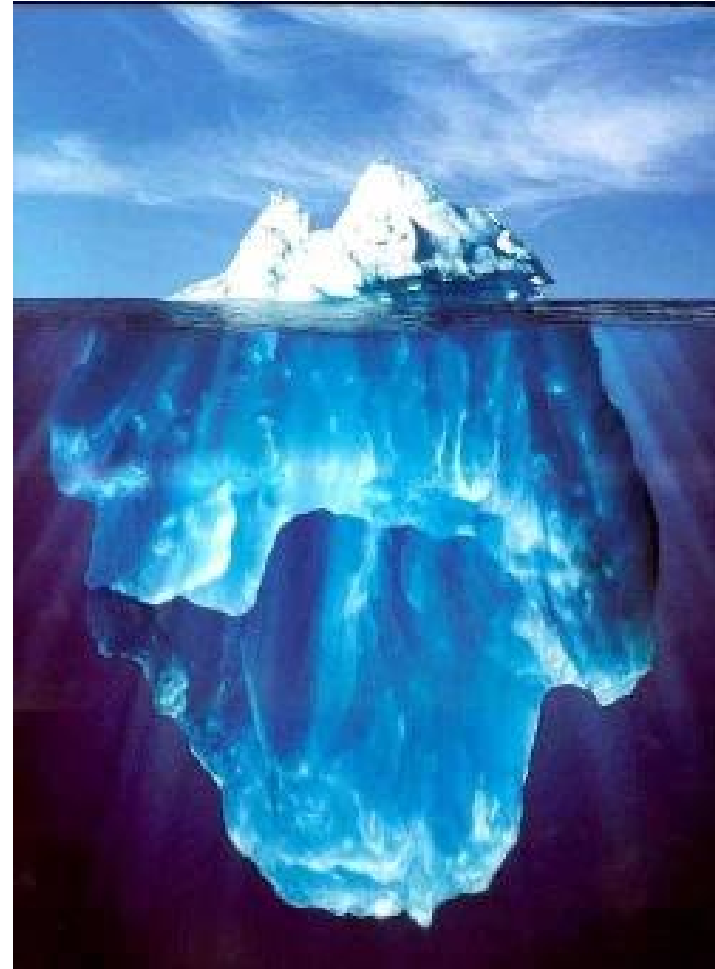

# Centre for Advanced Technologies

- Administered technologies

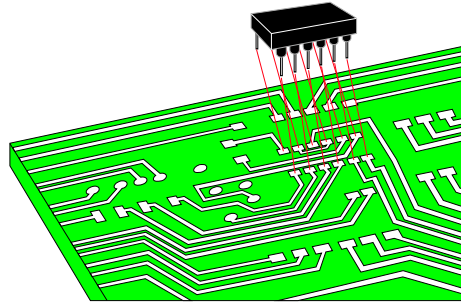

- Communications

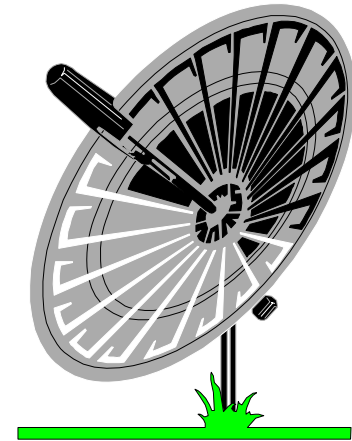

- Energy

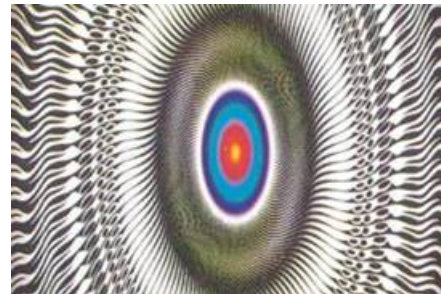

# Centre for Advanced Technologies

- Complementary Medicine



- Agriculture



- Food

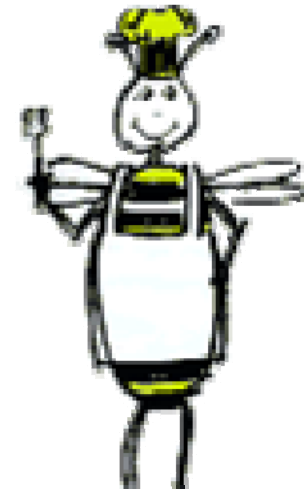

# Centre for Advanced Technologies

- Housing

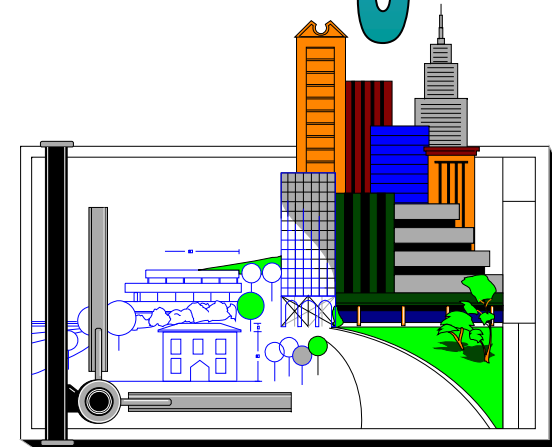

- Environmental



- Resources





# PASCAS CARE CENTRES





# PASCAS CARE CENTRE

- **A Pascas Care Centre in an emerging economy may facilitate and focus upon the following:**
- **Medical Clinicians with satellite broadband communication linkage to the core centres within the network.**
- **Focus on:**
  - **Pre-natal / post natal services.**
  - **Immunisation**
  - **Dental**
  - **Eyes**
  - **Nutrition**

# PASCAS HEALTH CLINIC

- **General Practitioners / Physicians will be supported by visiting specialist:**
  - **Obstetrics & Gynaecology**
  - **Orthopaedics**
  - **Dermatology**
- **Units will incorporate:**
  - **Pharmacy**
  - **Optometry**
  - **Physiotherapy**
  - **Radiology**

# PASCAS HEALTH CLINIC

- **Day theatre capabilities will undertake a wide range of procedures.**
- **Ozone Therapy unit will have 12 beds / chairs available as well as the AIDs Serum unit will have available a further 15 beds / chairs. Treatments in both segments extends to a wide range of life threatening diseases.**
- **Nutritional training for patients and their family will be facilitated through the attached training kitchen being adjacent to dining / training rooms.**

# PASCAS HEALTH CLINIC

- **Having extensive office facilities and meeting rooms within the Pascas Health Clinic enables Pascas to support the introduction of new technologies to grow employment and skill levels for patients and their families.**
- **The agenda is to treat the cause, not the symptoms as well as to bring gainful employment and prosperity into the community which Pascas will be.**

# PASCAS HEALTH

**To find our way  
home, we must  
remember who  
we are!**

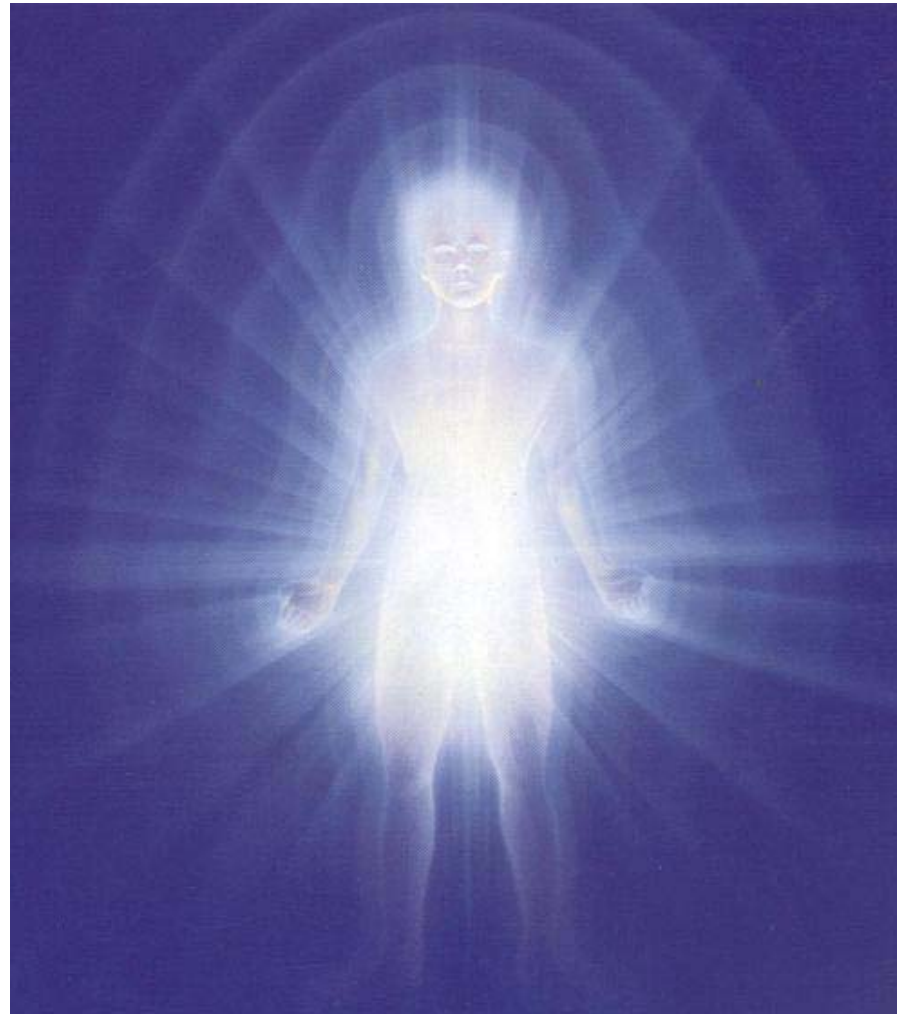



The Auric Fields of a Couple in Love



# PASCAS HEALTH



This presentation on the  
Map of Consciousness  
calibrates over 880

**"Beacons of Light"  
around the globe**